

About this Manual

We've added this manual to the Agilent website in an effort to help you support your product. This manual is the best copy we could find; it may be incomplete or contain dated information. If we find a more recent copy in the future, we will add it to the Agilent website.

Support for Your Product

Agilent no longer sells or supports this product. Our service centers may be able to perform calibration if no repair parts are needed, but no other support from Agilent is available. You will find any other available product information on the Agilent Test & Measurement website, www.tm.agilent.com.

HP References in this Manual

This manual may contain references to HP or Hewlett-Packard. Please note that Hewlett-Packard's former test and measurement, semiconductor products and chemical analysis businesses are now part of Agilent Technologies. We have made no changes to this manual copy. In other documentation, to reduce potential confusion, the only change to product numbers and names has been in the company name prefix: where a product number/name was HP XXXX the current name/number is now Agilent XXXX. For example, model number HP8648A is now model number Agilent 8648A.

Notice

Hewlett-Packard to Agilent Technologies Transition

This documentation supports a product that previously shipped under the Hewlett-Packard company brand name. The brand name has now been changed to Agilent Technologies. The two products are functionally identical, only our name has changed. The document still includes references to Hewlett-Packard products, some of which have been transitioned to Agilent Technologies.

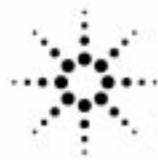

Agilent Technologies

HP 8591C
Cable TV Analyzer
Cable TV Measurements

HP part number: 08591-90176 Supersedes: 08591-90124
Printed in USA, October 1996

Notice.

The information contained in this document is subject to change without notice.

Hewlett-Packard makes no warranty of any kind with regard to this material, including but not limited to, the implied warranties of merchantability and fitness for a particular purpose. Hewlett-Packard shall not be liable for errors contained herein or for incidental or consequential damages in connection with the furnishing, performance, or use of this material.

Regulatory Information.

The regulatory information is in the calibration guide for your analyzer.

©Copyright 1996 Hewlett-Packard Company
All Rights Reserved. Reproduction, adaptation, or translation without prior written permission is prohibited, except as allowed under the copyright laws
1400 Fountaingrove Parkway, Santa Rosa, CA 95403-1799, USA

Hewlett-Packard Software Product License Agreement and Limited Warranty

Important

Please carefully read this License Agreement before opening the media envelope or operating the equipment. Rights in the software are offered only on the condition that the Customer agrees to all terms and conditions of the License Agreement. Opening the media envelope or operating the equipment indicates your acceptance of these terms and conditions. If you do not agree to the License Agreement, you may return the unopened package for a full refund.

License Agreement

In return for payment of the applicable fee, Hewlett-Packard grants the Customer a license in the software, until terminated, subject to the following:

Use.

- Customer may use the software on one analyzer instrument
- Customer may not reverse assemble or decompile the software.

Copies and Adaptations.

- Customer may make copies or adaptations of the software:
 - For archival purposes, or
 - When copying or adaptation is an essential step in the use of the software with a computer so long as the copies and adaptations are used in no other manner.
- Customer has no other rights to copy unless they acquire an appropriate license to reproduce which is available from Hewlett-Packard for some software.
- Customer agrees that no warranty, free installation, or free training is provided by Hewlett-Packard for any copies or adaptations made by Customer.
- All copies and adaptations of the software must bear the copyright notices(s) contained in or on the original.

Ownership.

- Customer agrees that they do not have any title or ownership of the software, other than ownership of the physical media.
- Customer acknowledges and agrees that the software is copyrighted and protected under the copyright laws.
- Customer acknowledges and agrees that the software may have been developed by a third party software supplier named in the copyright notice(s) included with the software, who shall be authorized to hold the Customer responsible for any copyright infringement or violation of this License Agreement.

Transfer of Rights in Software.

- Customer may transfer rights in the software to a third party only as part of the transfer of all their rights and only if Customer obtains the prior agreement of the third party to be bound by the terms of this License Agreement.
- Upon such a transfer, Customer agrees that their rights in the software are terminated and that they will either destroy their copies and adaptations or deliver them to the third party.
- Transfer to a U.S. government department or agency or to a prime or lower tier contractor in connection with a U.S. government contract shall be made only upon their prior written agreement to terms required by Hewlett-Packard.

Sublicensing and Distribution.

- Customer may not sublicense the software or distribute copies or adaptations of the software to the public in physical media or by telecommunication without the prior written consent of Hewlett-Packard.

Termination.

- Hewlett-Packard may terminate this software license for failure to comply with any of these terms provided Hewlett-Packard has requested Customer to cure the failure and Customer has failed to do so within thirty (30) days of such notice.

Updates and Upgrades.

- Customer agrees that the software does not include future updates and upgrades which may be available for HP under a separate support agreement.

Export.

- Customer agrees not to export or re-export the software or any copy or adaptation in violation of the U.S. Export Administration regulations or other applicable regulations.

Limited Warranty

Software.

Hewlett-Packard warrants for a period of 1 year from the date of purchase that the software product will execute its programming instructions when properly installed on the analyzer instrument indicated on this package. Hewlett-Packard does not warrant that the operation of the software will be uninterrupted or error free. In the event that this software product fails to execute its programming instructions during the warranty period, customer's remedy shall be to return the measurement card ("media") to Hewlett-Packard for replacement. Should Hewlett-Packard be unable to replace the media within a reasonable amount of time, Customer's alternate remedy shall be a refund of the purchase price upon return of the product and all copies.

Media.

Hewlett-Packard warrants the media upon which this product is recorded to be free from defects in materials and workmanship under normal use for a period of 1 year from the date of purchase. In the event any media prove to be defective during the warranty period, Customer's remedy shall be to return the media to Hewlett-Packard for replacement. Should Hewlett-Packard be unable to replace the media within a reasonable amount of time, Customer's alternate remedy shall be a refund of the purchase price upon return of the product and all copies.

Notice of Warranty Claims.

Customer must notify Hewlett-Packard in writing of any warranty claim not later than thirty (30) days after the expiration of the warranty period.

Limitation of Warranty.

Hewlett-Packard makes no other express warranty, whether written or oral, with respect to this product. Any implied warranty of merchantability or fitness is limited to the 1 year duration of this written warranty.

This warranty gives specific legal rights, and Customer may also have other rights which vary from state to state, or province to province.

Exclusive Remedies.

The remedies provided above are Customer's sole and exclusive remedies. In no event shall Hewlett-Packard be liable for any direct, indirect, special, incidental, or consequential damages (including lost profit) whether based on warranty, contract, tort, or any other legal theory.

Warranty Service.

Warranty service may be obtained from the nearest Hewlett-Packard sales office or other location indicated in the owner's manual or service booklet.

Safety Symbols

The following safety symbols are used throughout this manual. Familiarize yourself with each of the symbols and its meaning before operating this instrument.

CAUTION

The *caution* sign denotes a hazard. It calls attention to a procedure which, if not correctly performed or adhered to, could result in damage to or destruction of the instrument. Do not proceed beyond a *caution* sign until the indicated conditions are fully understood and met.

WARNING

The *warning* sign denotes a hazard. It calls attention to a procedure which, if not correctly performed or adhered to, could result in injury or loss of life. Do not proceed beyond a *warning* sign until the indicated conditions are fully understood and met.

General Safety Considerations

WARNING

Before the analyzer is switched on, make sure it has been properly grounded through the protective conductor of the ac power cable to a socket outlet provided with protective earth contact.

Any interruption of the protective (grounding) conductor, inside or outside the instrument, or disconnection of the protective earth terminal can result in personal injury.

CAUTION

Before the analyzer is switched on, make sure its primary power circuitry has been adapted to the voltage of the ac power source.

Failure to set the ac power input to the correct voltage could cause damage to the instrument when the ac power cable is plugged in.

The HP 85721A with Supported Analyzer

The HP 85721A with supported analyzer can perform tests channel-by-channel, or over multiple channels with multiple tests performed on each channel. (Refer to Chapter 1 for supported analyzer information.)

With the Option 107 TV receiver, the analyzer provides video testing and TV receiver capability. The HP 85721A with supported analyzer has three operating modes:

1. Spectrum analyzer
 2. Cable TV analyzer
 3. TV receiver
1. The analyzer is a full-featured spectrum analyzer. Some key spectrum analysis features include the following:
 - Zoom window
 - Analog+ display (digital implementation of an analog display)
 - Peak zoom
 - Title, execute remote commands, and edit DLPs with a PC keyboard
 - Adjacent channel power, occupied BW, and channel power
 - Multiple markers and marker table
 - Peak table
 - % AM, TOI, and N dB bandwidth
 - AM measurements with FFT menu
 - Gate driver (Option 105 or 107 required)
 2. The HP 85721A with supported analyzer is a cable TV analyzer. With the Option 107 added, the analyzer can also perform three video measurements: differential gain, differential phase, and chrominance-to-luminance delay inequality. In addition, the Option 107 allows the analyzer to perform previously interfering RF measurements in a non-interfering manner. That is, carrier-to-noise ratio, composite second order distortion, and in-channel frequency response tests can be performed without disrupting service.

There are two measurement modes within the cable TV analyzer mode of operation:

- Channel measurement mode
- System measurement mode

Channel measurement mode is used to perform channel-by-channel measurements. That is, you can execute a single measurement on a single channel.

System measurement mode is used to create test plans that allow you to execute selected (or all) measurements on a selected channel or range of channels. After setting up these test plans, system measurement mode is used to execute a test plan immediately, or schedule the tests to be performed at a later time. Measurement results can be stored to a RAM card, sent to the screen for viewing, or dumped to a printer.

3. The HP 85721A with supported analyzer is a TV receiver (Option 107 required). You can listen to the sound and see the picture simultaneously. This allows you to quickly identify picture quality problems such as noise, distortion, hum, and ingress.

In This Guide

- Chapter 1 explains how to install the personality and access channel or system measurement mode.
- Chapter 2 provides information about performing channel-by-channel cable TV measurements using the channel measurement mode.
- Chapter 3 provides information about performing cable TV measurements by creating and executing a test plan using the system measurement mode. In addition, information about storing and recalling test plans and test data to and from a RAM card is provided.
- Chapter 4 contains information about what to do if you have a problem.
- Chapter 5 contains menu maps and descriptions of softkey functions in the channel measurement mode.
- Chapter 6 contains menu maps and descriptions of softkey functions in the system measurement mode.
- Chapter 7 contains menu maps and descriptions of softkey functions in the Setup menu.
- Chapter 8 provides descriptions of all tests.
- Chapter 9 contains specifications and characteristics of the HP 85721A Cable TV Measurements and System Monitor Personality with supported analyzer. In addition, channel identification plans and a channel survey map for characterizing your system are provided as test aids.

Conventions

This guide uses the following conventions:

Front-Panel Key

A boxed, uppercase name in this typeface represents a key physically located on the instrument.

Softkey

A boxed word written in this typeface indicates a “softkey,” a key whose label is determined by the instrument’s firmware.

Softkey ON OFF (ON)

A boxed word written in this typeface with the words ON and OFF can turn a function on or off. The underlined function is shown in parenthesis.

Softkey AUTO MAN (AUTO)

A boxed word written in this typeface with the words AUTO and MAN can either be auto-coupled or have its value manually changed. The underlined function is shown in parenthesis.

Screen Text

Text printed in this typeface indicates text displayed on the spectrum analyzer screen.

Analyzer Operation

NOTE

If you are not familiar with your analyzer, refer to the analyzer's installation and operation and programming manuals. These manuals describe analyzer preparation and verification, and tell you what to do if something goes wrong. Also, they describe analyzer features and tell you how to make spectrum analyzer measurements. Consult these manuals whenever you have a question about standard analyzer use.

Firmware Requirements

Your analyzer must have firmware that was released on September 23, 1993 or later to use the HP 85721A personality To determine the firmware date for your analyzer:

- Turn on the analyzer.
- Read the firmware date that is displayed (the firmware date is displayed on the analyzer's display when the analyzer is first turned on). The date is displayed in a day, month, year format. For example, if rev 930923 is displayed, the release date of the firmware was September 23, 1993.

If the release date for the analyzer's firmware was prior to September 23, 1993, the firmware must be updated to use the HP 85721A personality Contact your HP sales office for more information about updating analyzer firmware.

Contents

1. Getting Started

What You'll Find in This Chapter	1-2
Supported Spectrum Analyzer Requirements	1-3
Setup for Cable TV Measurements	1-4
Step 1. Load the HP 85721A personality into analyzer memory	1-5
Step 2. Perform the self-calibration routines	1-8
Step 3. Install a printer	1-10
Step 4. Connect cables for non-interfering measurements	1-12
Step 5. Start channel or system mode of operation	1-14
Deleting the HP 85721A Personality from the Analyzer	1-15

2. Channel Measurements

What You'll Find in This Chapter	2-2
Making Channel Measurements	2-3
Step 1. Configure the test system	2-4
Step 2. Connect the signal to the analyzer	2-9
Step 3. Make the measurements	2-11
Method #1 - Tune by center frequency and frequency span	2-42
Method #2 - Tune by start and stop frequencies	2-43
Step 4. Access the spectrum analyzer mode	2-62
Step 5. Access the TV receiver mode (optional)	2-63

3. System Measurements

What You'll Find in This Chapter	3-2
Making System Measurements	3-3
Step 1. Configure the test system	3-4
Step 2. Connect the signal to the analyzer	3-8
Step 3. Enter the location code	3-10
Step 4. Enter the temperature	3-11
Step 5. Recall a test plan	3-12
Step 6. Make the measurements now	3-14
Step 7. Access the spectrum analyzer mode	3-18
Step 8. Access the TV receiver mode (optional)	3-19

Making Timed System Measurements	3-20
Creating a Test Plan	3-22
Step 1. Select an individual channel	3-23
Step 2. Select a range of channels (optional)	3-25
Step 3. Save the current test plan in internal memory	3-28
Step 4. Save the current test plan to a RAM card (optional)	3-30
Editing the Current Test Plan	3-31
Clearing the Current Test Plan	3-32
Cataloging Analyzer Memory	3-33
Recalling a Test Plan from a RAM Card	3-34
Recalling Test Data from the RAM Card	3-35
Cataloging a RAM Card	3-36
Formatting a RAM Card	3-37
Deleting All the Files from a RAM Card	3-38
Deleting Individual Files from a RAM Card	3-39

4. If You Have a Problem

Error Messages	4-3
ALREADYENTERED	4-3
CAUTION - Recalled Test Plan Corrupted Selected Test Plan Cleared	4-4
CAUTION - STOP TIME ALREADYPASSED	4-4
CAUTION - STOP TIME LESS THAN STARTTIME. SET STOP TIMEANDTRYAGAIN	4-5
CHECK CARD IN SLOT (SAVE OFF?)	4-5
ILLEGAL COMMAND	4-6
INVALID SYMTAB ENTRY: SYMTAB OVERFLOW	4-6
INVALID FILE NO ROOM	4-7
MUST BE > FIRST.	4-7
NO CARD FOUND	4-8
NO TEST PLAN SELECTED	4-a
OUTOFRANGE	4-9
PLEASE SELECT A CHANNEL	4-9
PRINTER IS NOT CONNECTED, NOTTURNED ON, OR A CONTROLLERCONFLICTEXISTS	4-10
RAM CARD REQUIRED	4-11
RAM CARD IS NOT FORMATTED, FORMAT RAM CARD AND TRY AGAIN	4-11
VIDEO SYNC NOT RECOGNIZED	4-11
Other Problems	4-12

If a test fails in SYSTEM MEAS mode	4-12
If files are missing from a RAM card	4-12
If a “-” appears in the data fields	4-13
If the test results are not what you expected	4-14
If the wrong date or time is displayed	4-15
How to Contact Hewlett-Packard	4-16

5. Channel Measurements Menu Map and Softkey Descriptions

What You’ll Find in This Chapter	5-2
Channel Measurements Menu Map	5-3
Channel Measurements Softkey Function Descriptions	5-8
CHANNEL SELECT Description	5-9
DL DELTA ON OFF Description	5-12
DO FRQ RESP TST Description	5-14
GATE ON OFF Description	5-17
LISTEN ON OFF Description	5-19
RECALL FRM INT Description	5-20
SAVE TRB TO INT Description	5-21
TAKE REF TRACE Description	5-23
VIEW CO-CHNL Description	5-27

6. System Measurements Menu Map and Softkey Descriptions

What You’ll Find in This Chapter	6-2
System Measurements Menu Map	6-3
System Measurements Softkey Function Descriptions	6-6
ABORT Description	6-6
ALL TESTS Description	6-6
CATALOG CARD Description	6-7
CLEAR TESTS Description	6-9
CLEAR TST PLAN Description	6-9
Create TstPlan Description	6-10
DATA TO PRINTER Description	6-10
DONE Description	6-13
DUMP TO PRINTER Description	6-13

DUMP TO RAM CARD Description	6-16
DUMP TO SCREEN Description	6-17
ENTER BY CHANNEL Description	6-18
ENTER BY RANGE Description	6-18
ENTER LOCATION Description	6-19
ENTER TEMP Description	6-20
GOTO PAGE Description	6-21
Main Menu Description	6-21
Measure Now Description	6-22
NEXT PAGE Description	6-22
NO Description	6-23
PLAN 1 Description	6-23
PLAN 2 Description	6-24
PLAN 3 Description	6-25
PLAN 4 Description	6-25
PLAN 5 Description	6-25
Prev Menu Description	6-26
PREV PAGE Description	6-26
PRINT REPORT Description	6-26
Recall Data Description	6-27
RECALL FRM CRD Description	6-27
RECALL FRM INT Description	6-28
Recall TstPlan Description	6-29
SAVE TO INT MEM Description	6-29
SAVE TO MEM CRD Description	6-30
Save TstPlan Description	6-30
START TIME Description	6-31
STOP TIME Description	6-31
SYSTEM MEAS Description	6-32
Timed Measure Description	6-33

TIME INTERVAL Description	6-34
TODAY' S DATE Description	6-35
TODAY' S TIMEDATE Description	6-35
VIEW CH SEL Description	6-36
VIEW LAST Description	6-36
YES Description	6-37
7. TV Receiver, Setup, and AUX CTRL Menu Maps and Softkey Descriptions	
What You'll Find in This Chapter	7-2
TV RECEIVER Menu Map	7-3
Setup Menu Map	7-4
AUX CTRL Menu Map	7-5
Softkey Descriptions	7-6
AIR Description	7-6
Analyzer Input Description	7-7
CHANNEL SELECT Description	7-8
Channel Tuning Description	7-8
CSO FREQ OFFSET and CTB FREQ OFFSET	
Description	7-9
EXT AMP GAIN Description	7-10
EXT AMP NZ FIG Description	7-10
EXT AMP YES NO Description	7-11
EXT PAD YES NO Description	7-11
HRC Description	7-12
IRC Description	7-13
Monitor TV Description	7-13
PICTURE ON OFF Description	7-14
PIX &SND ON OFF Description	7-14
Setup Description	7-15
SOUND ON OFF Description	7-16
STD Description	7-16
SYS BTS TST CHNL Description	7-17

System Beats Description	7-18
T Description	7-19
TOTL PWR @ INPUT Description	7-20
TV RECEIVER Description	7-20
USR CH 0 CMTR FRQ Description	7-21
USR CH 0 SPAM Description	7-21
8. Test Descriptions	
What You'll Find in This Chapter	8-2
Visual Carrier Level and Visual-to-Aural Level Difference Test Description	8-3
Visual Carrier Frequency and Visual-to-Aural Frequency Difference Test Description	8-5
Carrier-to-Noise Ratio Test Description	8-7
Composite Second Order (CSO) Test Description	8-16
Composite Triple Beat (CTB) Test Description	8-18
Hum Test Description	8-24
Depth of Modulation Test Description	8-28
Digital Channel Power Measurement Description	8-30
Color Test Descriptions (Chroma/Luma Delay Inequality, Differential Gain, Differential Phase)	8-33
In-Channel Frequency Response Test Description	8-40
FM Deviation Test Description	8-43
Cross Modulation Test Description	8-44
System Frequency Response Test Description	8-45
View Ingress Test Description	8-46
View Co-Channel Test Description	8-47
9. Specifications and Test Aids	
What You'll Find in This Chapter	9-2
Cable TV Measurement Specifications and Characteristics C/N, CSO, and CTB Measurements	9-6
System Frequency Response (flatness)	9-8
Video Measurements	9-9
Channel Identification Plans	9-10
Channel Survey Map	9-23

Glossary

Index

Figures

2-1. Channel Tuning Menu	2-5
2-2. Analyzer Input Configuration Menu	2-6
2-3. Tests Configuration Menu	2-8
2-4. Connecting the Cable to the Input Connector	2-10
2-5. Connections for HP 8591C analyzer with Option 107	2-10
2-6. Carrier Level Measurement	2-13
2-7. Carrier Frequency Measurement (100 Hz Resolution)	2-13
2-8. 10 Hz Resolution	2-14
2-9. Carrier-to-Noise-Modulation and Gating Off	2-15
2-10. See MORE INFO Screen	2-16
2-11. Example of a Quiet Line	2-17
2-12. Carrier-to-Noise-Modulation and Gating On	2-18
2-13. Carrier-to-Noise, More Information	2-19
2-14. FCC Composite Test Signal	2-22
2-15. NTC 7 Composite Test Signal	2-23
2-16. Chrominance to Luminance, More Information	2-24
2-17. CSO Measurement	2-29
2-18. CTB Measurement	2-29
2-19. Cross Modulation Measurement	2-30
2-20. Depth of Video Modulation Measurement	2-32
2-21. TV Line Number	2-33
2-22. Depth of Video Modulation, More Information	2-34
2-23. FCC Composite Test Signal	2-37
2-24. NTC 7 Composite Test Signal	2-38
2-25. Differential Gain/Differential Phase Measurement	2-40
2-26. Differential Gain/Differential Phase, More Information	2-41
2-27. Tuned Digital Channel Display	2-42
2-28. Results of Digital Channel Power Test	2-44
2-29. FM Deviation	2-47
2-30. Hum Measurement	2-49
2-31. Hum, More Information	2-49
2-32. Ghost Cancellation Reference (GCR)	2-53
2-33. FCC Multi-Burst Test Signal	2-54
2-34. NTC-7 Combination Multi-Burst Test Signal	2-54
2-35. Sine X/X Test Signal	2-55
2-36. Results with GCR or Line Sweep Test Signal	2-55
2-37. Results with FCC Multi-Burst Test Signal	2-56

2-38	More Information (Multi-Burst)	2-56
2-39	System Frequency Response Measurement	2-58
2-40	View Ingress	2-60
2-41	View Co-Channel Measurement	2-61
3-1	Channel Tuning Menu	3-5
3-2	Analyzer Input Configuration Menu	3-6
3-3	Connecting the Cable to the Input Connector	3-9
3-4	Connections for HP 8591C analyzer with Option 107 (RF Measurements)	3-9
3-5	Enter Location Menu	3-10
3-6	Enter Temperature Menu	3-11
3-7	Recall from Internal Analyzer Memory	3-13
3-8	Dump Options Menu	3-15
3-9	Tests Results Screen-Page 1	3-16
3-10	Tests Results Screen-Page 2	3-16
3-11	Tests Results Screen-Page 3	3-17
3-12	Timed System Measurements	3-21
3-13	Enter by Channel	3-24
3-14	Enter by Range-First Channel Number	3-27
3-15	Enter by Range-Last Channel Number	3-27
3-16	View Current Test Plan	3-32
3-17	Catalog Analyzer Internal Memory	3-33
3-18	A RAM Card	3-37
5-1	Channel Measurements Main Menu 1 of 3	5-4
5-2	Channel Measurements Main Menu 2 of 3	5-5
5-3	Channel Measurements Main Menu 3 of 3	5-6
5-4	DISPLAY Menu	5-7
5-5	Select Channel	5-9
5-6	Channel Selected	5-10
5-7	Display Line Delta	5-13
5-8	System Frequency Response	5-15
5-9	Trace B, Recalled	5-20
5-10	Trace B, Saved	5-21
5-11	Fast and Slow Sweep	5-23
5-12	Conditioned Reference Spectrum	5-25
5-13	Trace B Saved to Internal Memory	5-26
5-14	View Co-Channel	5-27
6-1	System Measurements Menu 1 of 2	6-4
6-2	System Measurements Menu 2 of 2	6-5
6-3	An Example of Cataloging a RAM Card	6-7
6-4	An Example Printout	6-11

6-5. An Example Printout	6-14
7-1. TV RECEIVER Menu Map	7-3
7-2. Setup Configuration Menu Map	7-4
7-3. <u>AUX CTRL</u> Menu Map	7-5
8-1. Measuring the Visual Level and Aural Carrier Difference	8-3
8-2. Measuring the Visual Frequency and Aural Frequency Difference	8-5
8-3. Carrier-to-Noise Measurement	8-9
8-4. MORE IMFO Screen	8-9
8-5. Determining the Level of the Beat Product and Noise Level . .	8-17
8-6. HUM, Video Modulation On	8-26
8-7. HUM, Video Modulation OFF	8-26
8-8. HUM, More Information	8-27
8-9. Measuring the Depth of Modulation	8-29
8-10. Tuned Digital Channel Display	8-30
8-11. Results of Digital Channel Power Test	8-32
8-12. FCC Composite Test Signal	8-34
8-13. NTC 7 Composite Test Signal	8-34
8- 14. Chrominance-to-Luminance Delay	8-35
8- 15. Differential Gain/Differential Phase	8-39
8- 16. In-Channel Frequency Response	8-40
8-17. Multi-Burst Response	8-41
8- 18. Cross Modulation	8-44
8-19. View Ingress	8-46
8-20. View Co-Channel	8-47

Tables

1- 1. Spectrum Analyzer Requirements for Running the HP 8572 1A Personality	1-3
2- 1. Channel Measurements	2-2
4-1. Ranges for the Cable TV System Monitor Functions	4-9
6-1. Cataloging a Memory Card	6-8
6-2. Information Contained in a Printout	6-12
6-3. Information Contained in a Printout	6-15
8-1. Auto Resolution Bandwidth (RBW) and Video Bandwidth (VBW) selection	8-31
8-2. Comparison of CLDI Measurement Values	8-36
9-1. FCC Numerical Designation of Television Channels (Section 73.603)	9-10
9-2. Channel Identification Plan EIA Interim Standard No. 6 (CP) and FCC Part 76.612	9-13
9-3. FM Broadcast Channels	9-19
9-4. T-Channels	9-22

Contents





Getting Started

Getting Started

What You'll Find in This Chapter

This chapter provides step-by-step procedures for setting up an analyzer to perform cable TV measurements using the HP 85721A Cable TV Measurements and System Monitor Personality. This chapter contains the following sections:

- supported spectrum analyzer requirements
- setup for cable TV measurements
- deleting the HP 85721A personality from the analyzer

Supported Spectrum Analyzer Requirements

The HP 85721A personality is designed to operate with the HP 8591C cable TV analyzer. However, certain spectrum analyzers can be used in place of the HP 8591C cable TV analyzer. The hardware and Firmware compatibility requirements for using spectrum analyzers are shown in the following table.

Table I-I. Spectrum Analyzer Requirements for Running the HP 85721A Personality

<ul style="list-style-type: none">● HP 8591C analyzer and HP 8590 E-Series spectrum analyzers are supported with firmware dated 930923 or later● Option 004 Precision Frequency Reference● Option 043 R-232 (or Option 021 HP-IB) Interface required for printer output and programming● Option 301 TV Sync Trigger/FADC (or Options 101 and 1021● Option 107 TV receiver required for video and gated measurements

NOTE

Options 004, 043, and 301 are standard with the HP 8591C analyzer. Also, the HP 85721A personality is pre-loaded into the HP 8591C analyzer.

Setup for Cable TV Measurements

This section explains the steps that are necessary to prepare the analyzer for making a measurement and printing out the results.

The steps are as follows:

- Load the HP 85721A personality into analyzer memory (if necessary).
- Perform the self-calibration routines.
- Install a printer.
- Connect cable for non-interfering measurements.
- Start channel or system mode of operation.

NOTE

The HP 85721A personality is pre-loaded into the HP 8591C analyzer.

Step 1. Load the HP 8572 1A personality into analyzer memory

1 Plug the analyzer into an ac power supply.

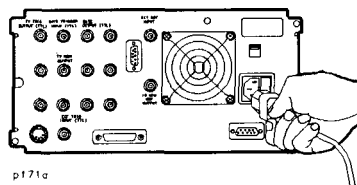

p171a

2 Press **LINE**. If CABLE TV ANALYZER and TV RECEIVER are displayed, skip to "Step 2. Perform the self-calibration routines."

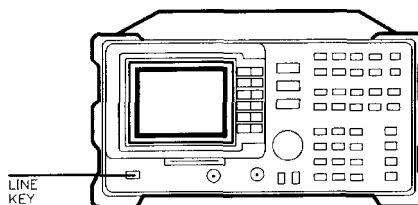

3 locate the arrow printed on the card label.

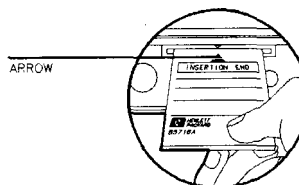

Setup for Cable TV Measurements

4 Insert the card into the analyzer with the card's arrow matching the raised arrow on the bezel around the card-insertion slot.

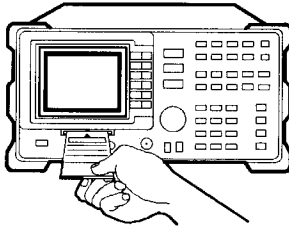

PY26A

5 Press **CONFIG**, MORE 1 of 3, Dispose User Mem, ERASE DLP MEM, ERASE DLP MEM. Press **PRESET**.

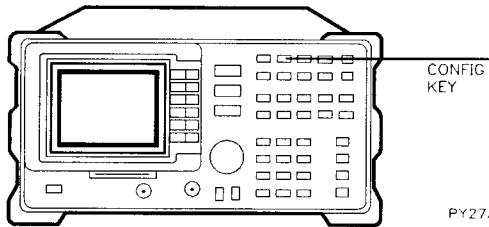

PY27A

6 Press **RECALL**. Press the **INTERNAL CARD** softkey so that **CARD** is underlined.

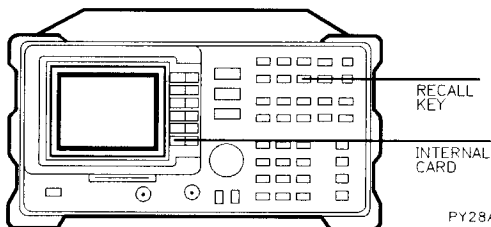

PY28A

Press the following **softkeys** to load the HP 85721A personality: **Catalog Card**, two files are displayed, **dLOADME** and **dCODE**. Using the step keys, make sure the file **dLOADME** is highlighted, then press **LOAD FILE**. When loading is complete, press **(MODE)**, **CODE LOADER**. Follow the on-screen instructions to complete the loading process.

If upgrading, first erase the DLP memory. See the section "Deleting the Personality" located in this chapter.

REF 48.8 dBmV AT 10 dB

PEAK HP859X 512

LOG	dLOADME-1	DLP	17	15	17:52:18	JAN 31, 1995
10	dCODE	DLP	32	435	07:19:35	FEB 08, 1995

dB/

SA SE

S C F

CORR

LOAD FILE

DELETE FILE

SELECT PREFIX

Exit Catalog

Previous Menu

CENTER 900 MHz

RES BW 3.0 MHz

SPAN 1.000 GHz

VBW 1 MHz

SWP 36.0 msec

T

Step 2. Perform the self-calibration routines

Allow the analyzer to warm up for 30 minutes before performing the following steps.

For the analyzer to meet its specifications and characteristics, the self-calibration routines should be performed periodically or whenever the ambient temperature changes. See the operating manual for the analyzer to determine how often the self-calibration routines should be performed.

Attach the calibration cable from the CAL OUT connector to the INPUT connector with the appropriate adapters

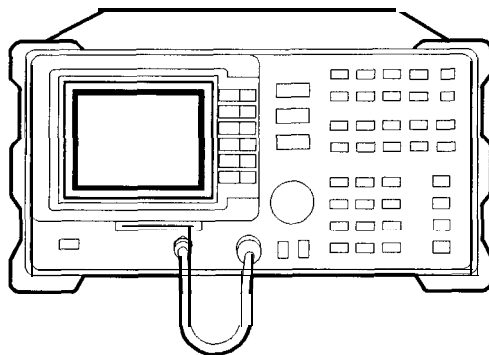

PY29A

! Press **CAL**, press **CAL FREQ & AMPTD** or, if the analyzer's amplitude calibration routine has been performed recently, press **CAL FREQ** instead of **CAL FREQ & AMPTD**. The analyzer's frequency and amplitude self-calibration routine take about 1.5 or 9 minutes to complete, respectively. If an error message is displayed, refer to the Installation and Verification Manual for the analyzer.

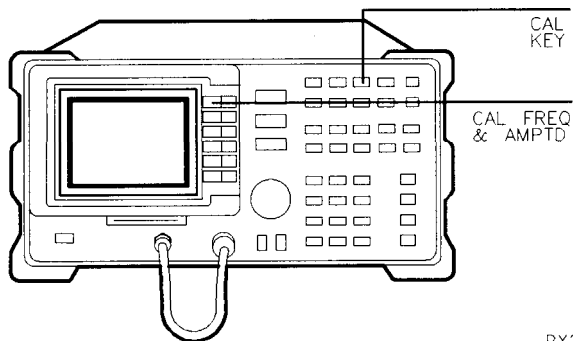

PY210A

| Press **CAL STORE**.

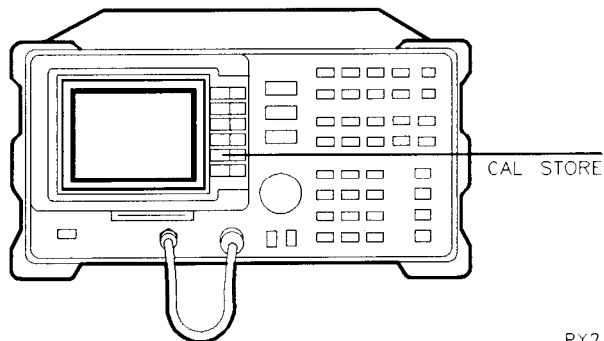

PY211A

Step 3. Install a printer

Steps 1 and 2 of this procedure apply to an analyzer with an HP-IB interface [Option 021] only. Skip to steps 3 and 4 if your analyzer has an RS-232 interface (Option 043).

Connect the analyzer to the printer, using an HP-IB cable. Turn the printer on.

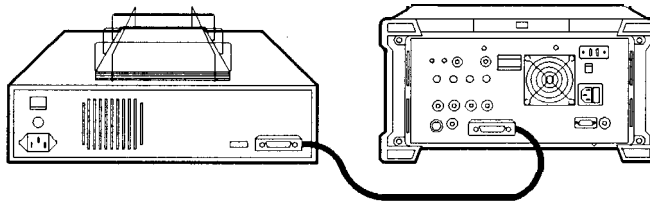

py213

Press **CONFIG**, **PRINT CONFIG**, **PRINTER ADDRESS**. Enter address that your printer is set to (usually at 1) using the data keys, then press **ENTER**. [See the printer's documentation for more information about the selection of the printer's address.] Then skip the following two steps and continue with the next step.

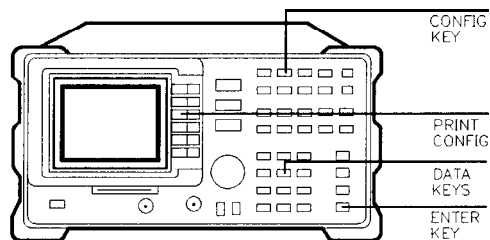

Steps 3 and 4 apply to an analyzer with an R-232 interface only. Refer to the *HP 8590 E-Series Spectrum Analyzer Programmer's Guide*, "Appendix C," for more information about using the RS-232 interface.

- 3 Connect the analyzer to the printer, using an HP 13242G, RS-232 cable. Turn the printer on.
PLOTTERS ARE NOT SUPPORTED BY THE HP 85721A PERSONALITY.

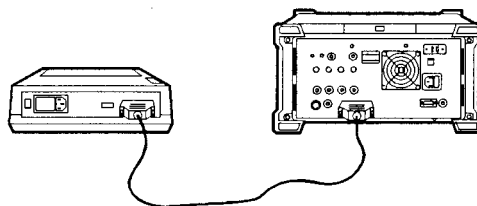

py215

- 4 Press **CONFIG** MORE 1 of 3, BAUD RATE, enter a baud rate with the data keys, then press **ENTER** to set the baud rate of the analyzer. **[The baud rate of the analyzer must match the baud rate of the printer.]**

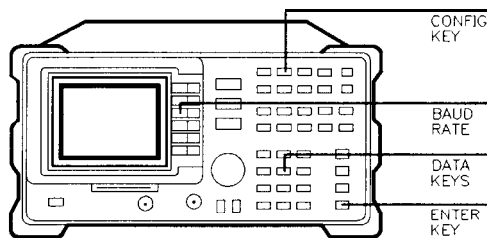

PY25A

NOTE

If you are using an HP 22250 RS-232 Thinkjet printer, refer to "Printing and Plotting" chapter of the User's Guide, for your spectrum analyzer, for information about Thinkjet switch settings.

Step 4. Connect cables for non-interfering measurements

Perform this procedure if you have Option 107 installed in your analyzer. [Option 107 is required for video and non-interfering measurements, and TV receiver mode of operation.] Otherwise, proceed to the next step.

- 1 Attach one right-angle BNC adapter to the TV TRIG OUTPUT (TTL) connector, and another right-angle BNC adapter to the GATE TRIGGER INPUT (TTL).

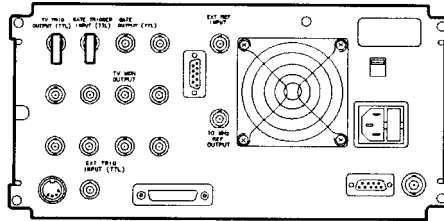

pf 73a

- 2 Connect a short BNC cable between the two adapters.

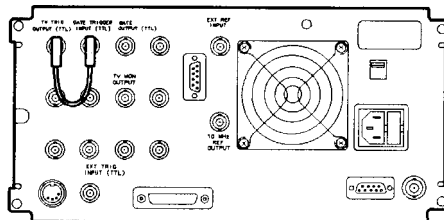

pf 74a

NOTE

- The above procedure is not required when the HP 8591C analyzer is purchased with Option 107 because the cable is pre-installed.
- When performing non-interfering measurements, the external coupler must also be connected. See Chapter 2, "Step 2. Connect the signal to the analyzer."

Step 5. Start channel or system mode of operation

Press **MODE**, **CABLE TV ANALYZER** to access the cable TV analyzer mode. Press **CHANNEL MEAS** to select measurements on a particular channel. Press **SYSTEM MEAS** to select measurements on groups of channels.

Note that when the analyzer is in channel mode, **CHNL** is displayed in the upper right corner of the analyzer display; **SYSTEM** is displayed in the upper right corner of the analyzer display when in system mode.

The **softkeys** accessed by pressing **Setup** allow you to customize the HP 85721A personality to your equipment and system. Chapters 2 and 3 contain information on how to use the **Setup** softkeys.

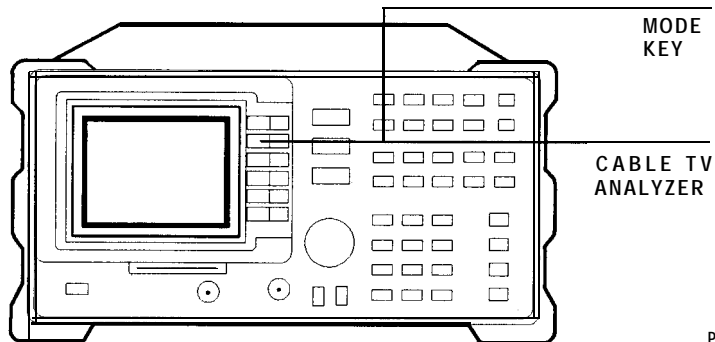

p f 75 a

Deleting the HP 85721A Personality from the Analyzer

The steps outlined below remove the HP 85721A personality tests and functions added to the analyzer by the ROM measurements card:

1. Press **PRESET**. Wait for the preset routine to finish.
2. Press **CONFIG** More 1 of 3 .
3. Press Dispose User Mem, ERASE DLP MEM , ERASE DLP MEM
4. Press **PRESET**.



Channel Measurements

Channel Measurements

What You'll Find in This Chapter

This chapter describes how to make cable TV measurements using the channel measurements mode of operation (CHANNEL MEAS). This chapter contains information on making channel measurements.

The tests are listed below along with the softkey that activates them.

Table 2-1. Channel Measurements

To activate	Press
Carrier Level and Frequency	CARRIER LVL&FRQ
Carrier to Noise	CARRIER/NOISE
Chroma/Luma Delay Inequality*	CLDI
Composite Second Order/Composite Triple Beat*	CSO/CTB
Cross Modulation	CROSSMOD
Depth of Video Modulation	DEPTH MOD
Differential Gain/Differential Phase*	DIF GAIN DIF PHAZ
Digital Channel Power	DIGITAL CH POWER
FM Deviation	FM DEV
Hum	HUM
In-Channel Frequency Response*	IN-CHNL FRQ RSP
System Frequency Response	SYSTEM FRQ RESP
View Ingress	VIEW INGRESS

* Option 107 required for non-interfering and video measurements.

Making Channel Measurements

This section explains the steps that are necessary to make channel measurements. The steps are as follows:

1. Configure the test system.
2. Connect the signal to the analyzer.
3. Make the measurements.
4. Access the spectrum analyzer mode.
5. Access the TV receiver mode (optional).

Step 1. Configure the test system

The Setup menu is used to set up channel tuning, a user defined channel, an external preamplifier, and an external matching pad (50 Ω analyzers only). In addition, gated (non-interfering) measurements can be configured (Option 107 required).

The information is stored in non-volatile analyzer memory. This means that the analyzer retains the information, even when power is turned off, until you access the Setup menu again and change it.

1. If the Setup softkey is displayed, press it now. Otherwise, press **MODE** CABLE TV ANALYZER Setup.
2. Press Channel Tuning, then press STD AIR HRC IRC T until the desired format is underlined.

The tune configuration menu allows you to select channel format:

- STD-Standard Cable
- AIR-Broadcast Channel
- HRC-HRC Cable
- IRC-IRC Cable
- T-Upstream Channels

USR CH 0 CNTR **FRQ** channel 0 center frequency

USR CH 0 SPAN channel 0 span

These keys allow you to define the center frequency and span for a user defined channel. This channel is then accessed by selecting channel "0" (zero).

3. Press Prev Menu to return to the Setup menu.

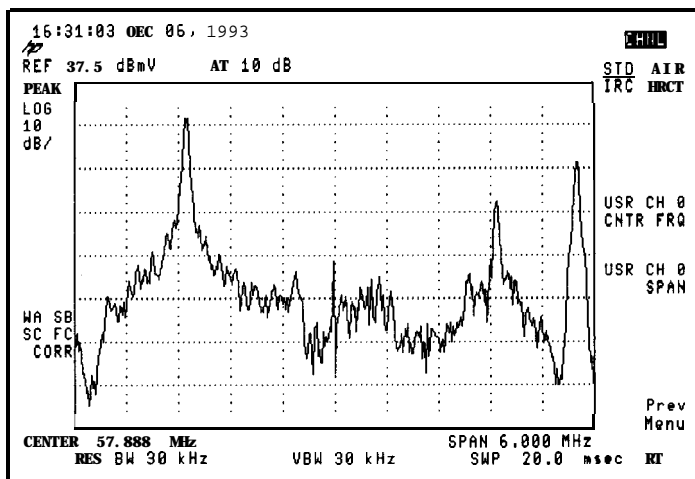

Figure 2-1. Channel Tuning Menu

4. *For spectrum analyzers with a 50 Ω input:* Use an external 50 Ω to 75 Ω matching pad/dc block to compensate for the impedance mismatch between a 75 Ω impedance system and the spectrum analyzer's 50 Ω input impedance. If you use an HP 11981A external pad, the external pad causes approximately 5.8 dB of amplitude loss. The external pad function (EXT PAD YES MO) can be used to compensate for this amplitude loss.

- Connect the matching pad to the spectrum analyzer input.
- Press Analyzer Input EXT PAD YES NO to underline YES.
- Press Prev Menu to return to the Setup menu.

If you are using a spectrum analyzer with 50 Ω input impedance but are not using an external matching pad/dc block, the analyzer will compensate for most of the impedance mismatch, but amplitude measurements can have up to ± 0.2 dB additional error caused by the uncompensated mismatch over the frequency range.

CAUTION

dc voltages in excess of 25 V and ac power-line voltages in excess of 100 V_{peak} can permanently damage the analyzer input.

5. *For using an external amplifier (preamp):* An external amplifier may be required for the carrier-to-noise test. See Chapter 8 for more information about when a preamplifier is required for the carrier-to-noise test. The

Making Channel Measurements

carrier-to-noise test calculates the noise contribution of the external amplifier and reports that correction on the MORE INFO screen of the carrier-to-noise test.

- Connect the output of the external amplifier to the analyzer input (or input of coupler).
- Connect the cable TV signal to the input of the external amplifier.
- Press Analyzer Input EXT AMP YES NO to underline YES.
- Press EXT AMP GAIN then enter the gain value of the external amplifier. The default value is 20 dB for the HP 85905A preamplifier.
- Press EXT AMP NZ FIG then enter the noise Eigure value of the external amplifier. The default value is 7 dB for the HP 85905A preamplifier.
- Press Prev Menu to return to the Setup menu.

The TOTL PWR @ INPUT function measures the total RF power into the analyzer. Use this function to externally adjust the total power into the analyzer or preamplifier for optimization of measurement dynamic range.

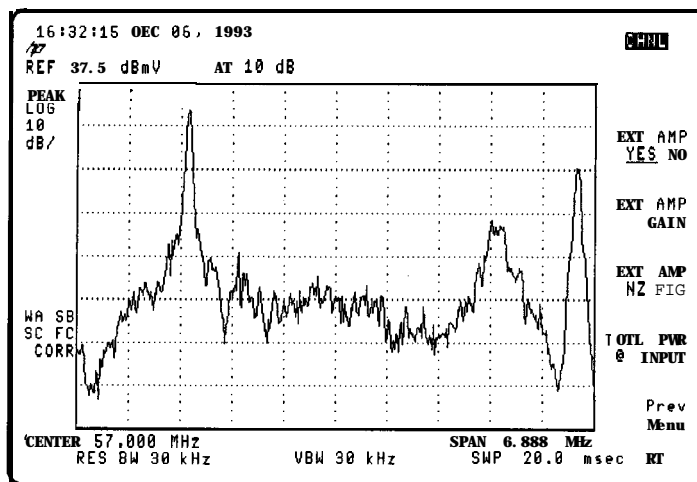

Figure 2-2. Analyzer Input Configuration Menu

6. For analyzers with Option 107: Press GATING YES NO to enable immediate gated (YES) or non-gated (NO) measurements. This function applies to the carrier-to-noise and CSO measurements only.

If GATING YES NO is set to YES, upon executing the carrier-to-noise or CSO measurements, the analyzer automatically searches for a quiet line (a line with no video modulation) starting at the default line.

NOTE

The default quiet line number for carrier-to-noise and CSO is 12, and both fields. The default line number for the in-channel frequency response test is 19, and both fields. For differential gain, differential phase, and chroma/luma delay inequality, the default test signal line number is 18, and the field is odd.

If the analyzer Ends a quiet line, and if PAUSE YES NO is set to NO, the analyzer will automatically execute the measurement without requiring the channel's video modulation to be turned off (non-interfering). If PAUSE YES NO is set to YES, the analyzer will pause upon Ending a quiet line. At this point, if a quiet line is displayed, press CONTINUE to execute the measurement. If a quiet line was not found, you must search for it using the \uparrow (step up) and \downarrow (step down) keys.

If GATING YES NO is set to NO, upon executing the carrier-to-noise or CSO measurements, you will be prompted to turn off modulation to execute the measurement in an interfering manner.

7. *For analyzers with Option 107:* Press PAUSE YES NO to select between pausing (YES) before executing a gated (non-interfering) or video measurement, or, upon Ending a quiet line or test signal, execute the measurement immediately (NO).

This function applies to carrier-to-noise and CSO when performing these measurements in a gated (non-interfering) manner. This function also applies to the video measurements: differential gain, differential phase, and chroma/luma delay inequality. When executing the video measurements, the analyzer automatically searches for the appropriate test signal. Refer to each test's description to see how each test operates.

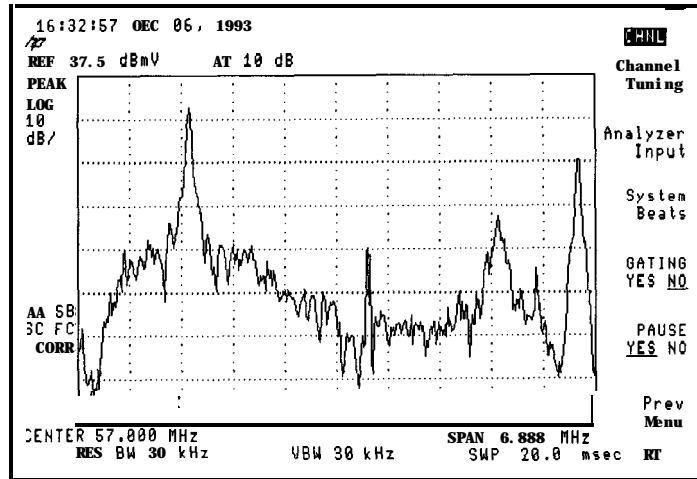

Figure 2.3. Tests Configuration Menu

8. Connect the cable TV signal as shown in “Step 2. Connect the signal to the analyzer.”

Step 2. Connect the signal to the analyzer

CAUTION

To prevent the analyzer input from being damaged, the total power at the analyzer input must be less than +72 dBmV.

To prevent the analyzer input mixer from being overloaded, the total power at the analyzer input mixer must be less than +37 dBmV except for CSO or CTB for which +27 dBmV is the maximum total power input to the mixer. For systems with unequal carrier levels (system tilt), the total power must be calculated by summing the individual carriers. The TOTL PWR \odot INPUT softkey function accounts for system tilt.

You can measure the input power by pressing Setup , Analyzer Input , TOTL PWR \odot INPUT The total power is displayed at the bottom of the screen.

Total power at the input mixer can be reduced by increasing input attenuation. Press **AMPLITUDE** **ATTEN** , and make the adjustment. The analyzer retains a manually selected attenuation until you either select a new value or reset the analyzer power-on default conditions. For all tests provided by the HP 85721A personality, the analyzer automatically selects the attenuator setting to meet the above requirements.

1. Use the necessary adapters to connect the cable TV signal to the analyzer. See Figure 2-4.
2. If your analyzer has Option 107 installed, you must use the coupler (provided) and connect the cable TV signal to the TV IN and analyzer input connectors as shown in Figure 2-5. Figure 2-5 shows the connections for RF and video measurements.
3. If your analyzer has Option 107 installed, ensure that the rear-panel TV TRIG OUT is connected to GATE IN as shown in Chapter 1, “Step 4. Connect cables for non-interfering measurements. ”

NOTE

The TV IN connector on the HP 8591C analyzer with Option 107 is located on the front panel. However, on HP 8590 E-Series spectrum analyzers with Option 107, the TV IN connector is located on the rear panel.

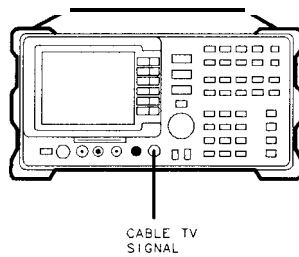

pf76a

Figure 2-4. Connecting the Cable to the Input Connector

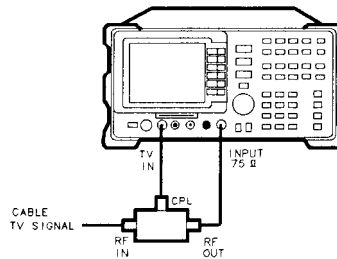

pf77a

Figure 2-5. Connections for HP 8591C analyzer with Option 107

Hints

You can return to the channel measurements softkeys by pressing **MODE**, **MODE**.

Step 3. Make the measurements

Most measurements update the result at the end of a sweep or at the end of multiple sweeps. Refer to each measurement type.

Hints

1. If you accidentally use the wrong key sequence, reenter the channel. If **CHANNEL SELECT** is the active function, enter the channel number, then press **ENTER**. Otherwise, press **CHANNEL SELECT**, enter the channel number, then press **ENTER**.
2. If you leave the cable TV **softkeys** (to use markers, for example) or exit a test incorrectly you can return to the last used cable TV menu by pressing the mode key twice: **MODE**, **MODE**.
3. In either of the above cases, or if you are lost in the **CABLE TV ANALYZER** mode, press **MODE** to reenter the **CABLE TV ANALYZER** mode, then enter a channel number.
4. If you want to set the analyzer to the power-on default conditions after using the cable TV functions, you can either cycle the power or press **PRESET**.
5. After exiting any test, you can step up or down to an adjacent numbered channel by pressing **↑** (step up) or **↓** (step down).
6. Appropriate vertical interval test signals (VITS) must be present for meaningful results in in-channel frequency response, differential gain and phase, and chromaluma delay inequality tests. Advertisement insertion equipment may cause the signals to be deleted during their active time.

Note that if a channel is not selected before executing a test the message **PLEASE SELECT A CHANNEL** will be displayed. A channel must be entered before continuing with the test.

Making Channel Measurements

Carrier level and
frequency test

1. Select a channel, then press CARRIER LVL&FRQ. The peak visual carrier level and visual-to-aural carrier difference appear on the screen. See Figure 2-6.
2. Press FREQ ON OFF to underline ON. The visual carrier frequency and visual-to-aural carrier frequency difference appear on the screen. See Figure 2-7.
3. Press FRQ RSLN 10 100 Hz to select between the readout resolution of 100 Hz or 10 Hz. 100 Hz is the default setting as 10 Hz significantly slows down the measurement. See Figure 2-8.
4. Press SCRAMBLD YES NO (YES) when measuring sync-suppressed scrambled channels. The analyzer performs a max hold.
5. Press NEXT CHANNEL to measure the next channel.
6. If you want to store the results to a RAM card, insert a formatted RAM card into the analyzer's card-insertion slot, press (SAVE) **display->card**, then press **MODE**, **MODE** to return to channel measurement mode. Refer to Chapter 3 for the procedure on formatting a RAM card.
7. If you want to print the results, press **COPY**.
8. Press MAIN MENU to exit the test

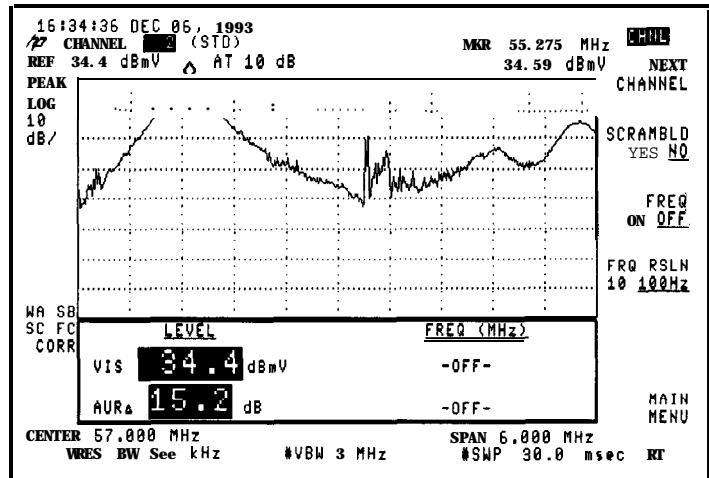

Figure 2-6. Carrier level Measurement

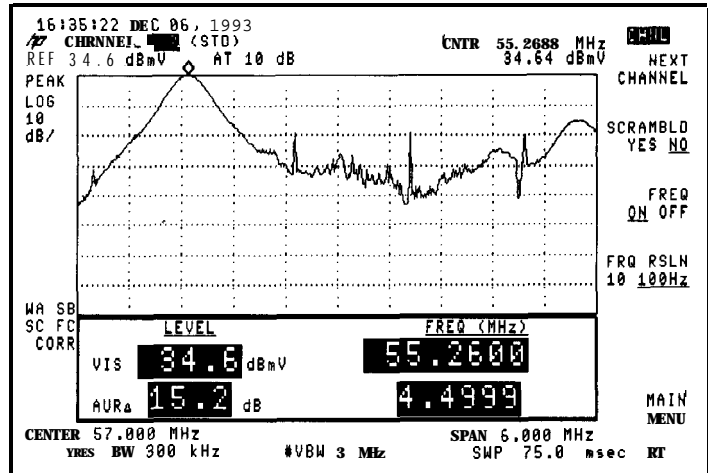

Figure 2-7. Carrier Frequency Measurement (100 Hz Resolution)

Channel Measurements
Making Channel Measurements

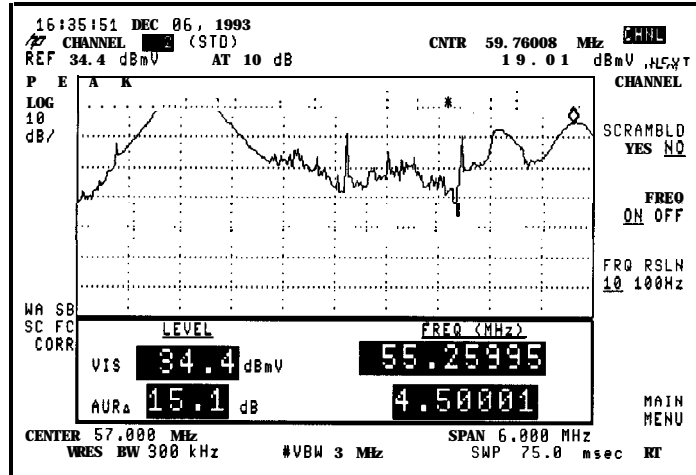

Figure 2-8. 10 Hz Resolution

Hints

For best results, the carrier-to-noise ratio (in 4 MHz BW) of the system should be 40 dB or greater, and the measured signal level should be 30 dB or greater above the displayed noise during the test.

Carrier-to-noise test

1. Select a channel, then press Main 1 of 3 CARRIER/NOISE
2. Perform the following steps for analyzers both without and with Option 107 (when GATING is set to NO):
 - a. The marker defaults to the minimum system noise near the lower channel boundary. Wait for the analyzer to return an answer.
 - b. To perform the carrier-to-noise test according to FCC requirements (unless using the component summation method), remove the modulation.
 - c. Using the knob, move the marker to the desired position in the indicated FCC MEASUREMENT RANGE, see Figure 2-9.

Note that the test compares the noise level at the analyzer input to that of the analyzer itself. If these levels are within 3 dB of each other, the analyzer will display the message (See MORE INFO) next to the measurement result. See Figure 2-10. If the difference is less than 2.2 dB, the message is in inverse video. Refer to Chapter 8 for more detailed information about the carrier-to-noise measurement.

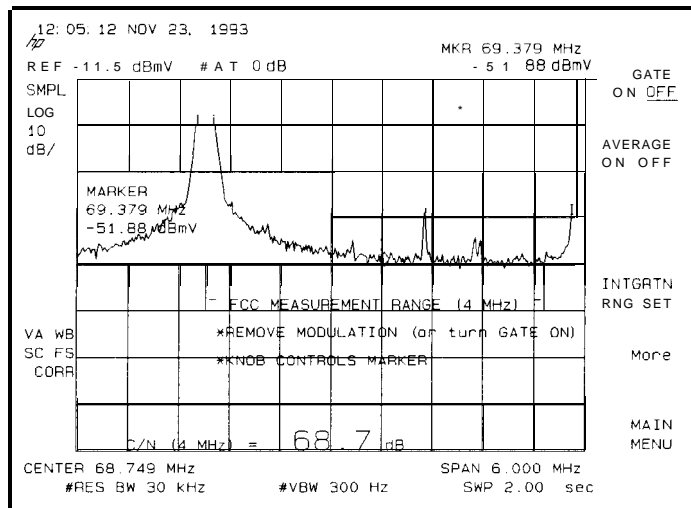

Figure 2-9. Carrier-to-Noise-Modulation and Gating Off

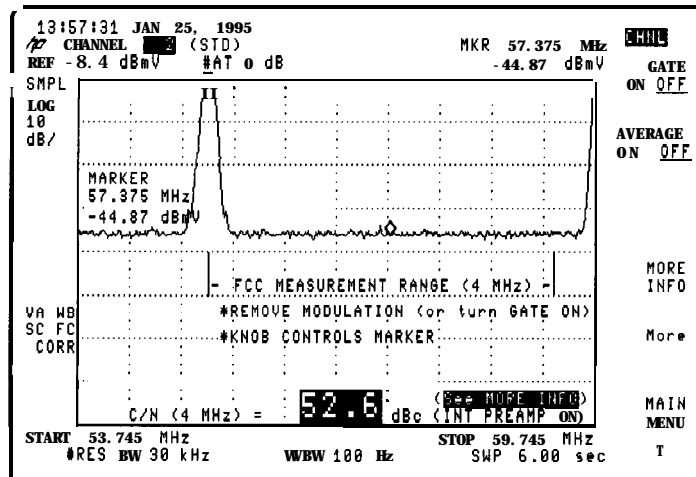

Figure 2-10. See MORE INFO Screen

3. Perform the following steps if your analyzer has Option 107 installed and you want to perform a gated (non-interfering) measurement (modulation turned on). Note that you will only have gotten to this point if GATING is set to NO.
 - a. Press GATE ON/OFF in the CARRIER/NOISE menu to perform a gated (non-interfering) measurement.
 - b. The analyzer will search for a quiet line and depending on the setting of PAUSE it will either pause or automatically continue if it finds a quiet line. If it does not End a quiet line it will display VIDEO SYNC NOT RECOGNIZED. At this point you can remedy the reason, or if a quiet line was not found because of noise, you can press LINE SEARCH to reinitiate a quiet line search. Another possible reason for failure to End a quiet line is that the input coupler is not in place with its coupled leg connected to TV IN.
 - c. Entering line numbers and the softkey FLD BOTH/EVEN/ODD can be used to manually search the vertical interval for a quiet line.

NOTE

Non-interfering carrier-to-noise cannot be measured without a quiet line. See Figure 2-11.

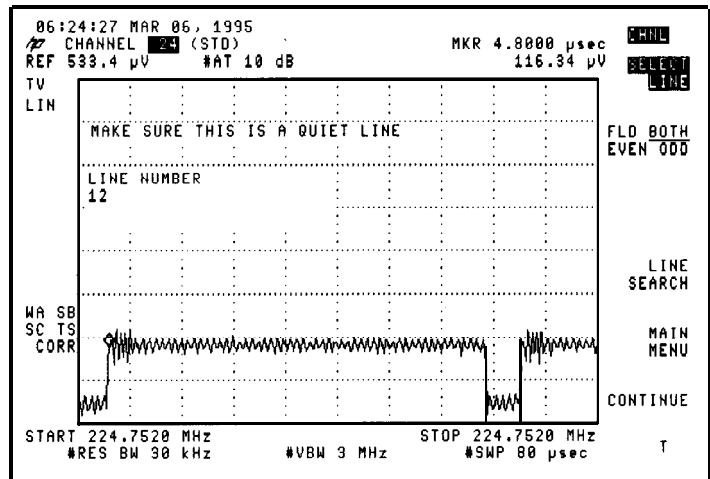

Figure 2-11. Example of a Quiet line

- d. Press CONTINUE to complete the measurement and display the test results on the screen. See Figure 2-12.
- e. The default center marker setting is +2.25 MHz above the visual carrier. The default integration range of 85% then places the outer integration range markers are then placed to measure the entire FCC measurement range excepting the carrier itself. The center marker can be moved using the front-panel knob.

Making Channel Measurements

NOTE

Spurious signals in the integration range can negatively affect the result because the power in the spurious signal is added into the noise level. It is best to find the reason for the spurious signal and eliminate it. But if this is not possible it is best to reduce the integration range and adjust its position so it does not include the spurious signal.

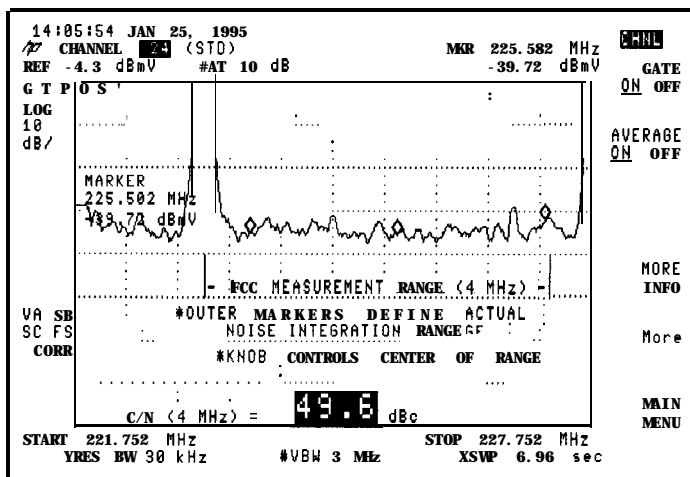

Figure 2.12. **Carrier-to-Noise—Modulation and Gating On**

NOTE

The **AVERAGE ON/OFF** key defaults to ON for the gated test because it is done with a wide video bandwidth. The non-gated test is done in a narrow video bandwidth so this key has less obvious effect in this mode.

4. If you want to store the results to a RAM card, insert a formatted RAM card into the analyzer's card-insertion slot, press (SAVE) **display**→**card** , then press **MODE** **MODE** to return to channel measurement mode. Refer to Chapter 3 for the procedure on formatting a RAM card.
5. If you want to print the results, press **COPY**.
6. Press MAIN MENU or More GO TO CSO/CTB to exit the test.
 - a. If GO TO CSO/CTB is pressed, the CSO/CTB test is entered without having to remeasure the carrier level.
 - b. If MAIN MENU is pressed and GATE ON/OFF is OFF, the message CHANNEL TURNED ON? will be displayed. Be sure the channel modulation is turned back on, then press MAIN MENU again.
7. Pressing **MORE INFO** displays the carrier-to-noise calculation. See Figure 2-13. Pressing RE-ENTER TEST restarts the test from the beginning. Pressing TTL PWR @ INPUT calculates the total input power making input level adjustments more convenient. Pressing MAIN MENU exits the test.

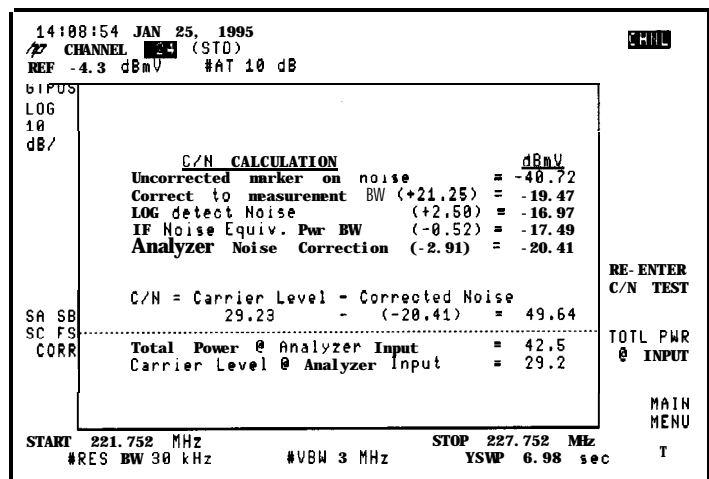

Figure 2-13. Carrier-to-Noise, More Information

Making Channel Measurements

Note that when an external preamplifier is used and EXT AMP YES NO is activated (YES is underlined), the noise contribution of the preamplifier is also calculated and corrected for. The values for external preamplifier gain and noise figure are used for this calculation. This is the only use made of the values entered with the external preamplifier softkeys (EXT AMP YES NO , EXT AMP GAIN , or EXT AMP **NZ** FIG).

Hints

1. When using a tunable bandpass filter, first peak the filter using **CARRIER LVL&FRQ**. Then press **CARRIER/NOISE**. Place the marker to measure the carrier-to-noise close enough to the carrier to minimize any roll-off effect of the bandpass filter.
2. Pressing **GO TO CSO/CTB** allows you to measure the CSOKTH without having to turn the modulation back on, then off again [for analyzers without Option 1071, or to reselect a quiet line (for analyzers with Option 107)].
3. Carrier-to-Noise Measurement Accuracy is degraded as the cable TV system noise approaches the analyzer noise. This is reflected in the magnitude of the Analyzer Noise Correction Value.
4. When in the carrier-to-noise measurement, press **More**, then **MORE INFO**. Note the analyzer noise correction value.
 - if less than 0.5 dB, then C/N accuracy ± 1 dB
 - if equal to 0.5 dB, then C/N accuracy ± 1.25 dB
 - if equal to 3 dB, then C/N accuracy ± 2 dB
 - if equal to 7 dB, then C/N accuracy ± 3.5 dB
 - if greater than 7 dB it is out of measurement range
5. The analyzer input attenuator sets the noise floor of the analyzer. The attenuator is set to overload the first mixer. For carrier to noise, the attenuator switch point from 0 to 10 dB is at +37 dBmV total power at the input.

Optimizing the Dynamic Range

Limiting the number of carriers input to the analyzer allows the measurement routine to select a lower attenuator value. Hence a lower noise floor. This can be done with individual channel filters, a high pass filter, a low pass filter or an adjustable **bandpass** filter.

When the attenuator switches to the next higher value, the noise floor raises 10 dB which degrades the signal to noise ratio by 10 dB. For C/N, the attenuator switches from 0 dB to 10 dB at +37 dBmV. Keeping the total power just below that will obtain the best signal to noise.

A 1 dB for smaller than 10 dB) step attenuator used in conjunction with a filter will provide the best coverage of signal range for optimizing the total power at the input.

Optimizing the Total Power at the Input

If the analyzer correction value dictates that it is necessary to optimize the analyzer noise floor for a particular configuration, press the following keys:

MODE

CABLE TV ANALYZER Setup Analyzer Input

TOTL PWR **Ⓢ** INPUT

For carrier to noise, the attenuator switch point from 0 dB to 10 dB attenuation is at +37 dBmV. It follows that the attenuator switch point from 10 dB to 20 dB is at +47 dBmV and increments proportionately with each 10 dB step in attenuation. For distortion measurements of CSO and CTB the attenuator switch point is +27 dBmV. Then it follows that the attenuator switch point from 10 dB to 20 dB is at +37 dBmV and increments proportionately for each 10 dB attenuator switch point.

**Chroma/luma delay
inequality test**

1. Select a channel, then press Main 1 of 3 Main 2 of 3 CLDI .

NOTE

Option 107 is required for the Chromalluma delay inequality test.

2. The line number of a test signal is found automatically (if a test signal exists). The search starts at the default line number (line 18). If a test signal is not found, the search routine will stop at the first NTC 7 or FCC composite test signal it finds while counting down from line 22 to line 10. Figure 2-14 shows the FCC composite test signal; Figure 2-15 shows the NTC 7 composite test signal.

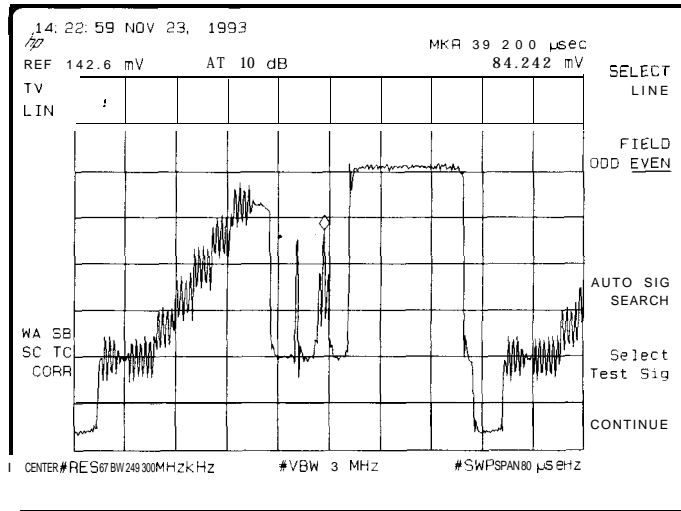

Figure 2-14. FCC Composite Test Signal

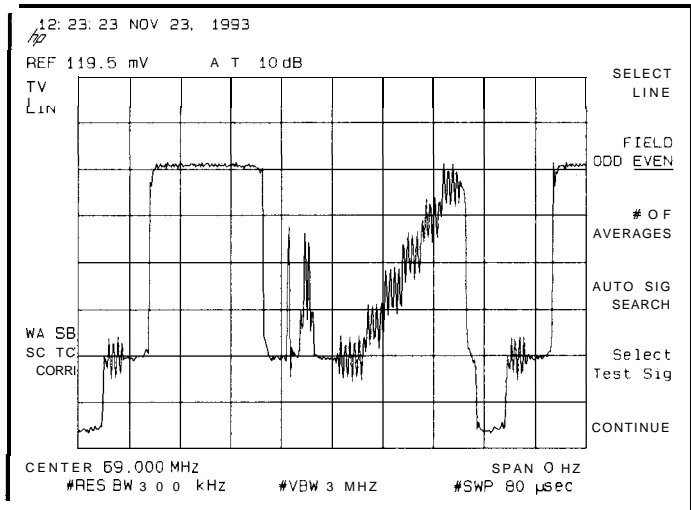

Figure 2-15. NTC 7 Composite Test Signal

NOTE

Chromalluma delay inequality measurements cannot be performed without a test signal line containing a 12.5T pulse. Non-standard test signal timing will affect results. The analyzer's internal frequency calibration routine should be run at the temperature testing is to be performed.

3. If the desired test signal is not displayed, press **SELECT LINE** then enter a line number, or press **AUTO SIG SEARCH** to execute the automatic search routine.
4. Press **FIELD ODD EVEN** if you need to change the field.

5. Press Select Test Sig if you need to change the test signal selection.
 - a. Press FCC COMPOSIT to select the FCC composite test signal, or NTC 7 CUMPOSIT to select the NTC 7 composite test signal. To assist in test signal identification a small schematic diagram of the test signal is displayed at the top of the screen.
 - b. Press Prev menu.
6. Press CONTINUE to perform the test.

The result of the measurement is displayed on the analyzer display. An offset of 170 ns is added to the result so that it will agree with tests done using a demodulator with 170 ns of delay. Modulators should be set for 170 ns precorrection. FCC requires measurements relative to this precorrection. The FCC tolerance is +/-170 ns.
7. Press MORE INFO to display chrominance to luminance response information. See Figure 2-16

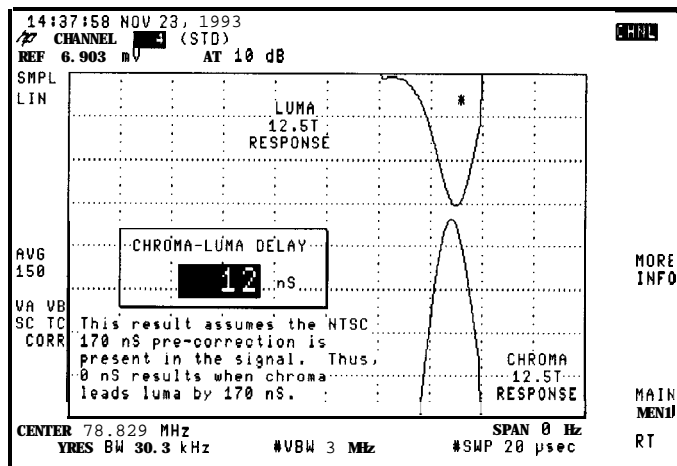

Figure 2-16. Chrominance to luminance, More Information

8. If you want to store the results to a RAM card, insert a formatted RAM card into the analyzer's card-insertion slot, press **SAVE** **display->card** , then press **MODE** **MODE** to return to channel measurement mode. Refer to Chapter 3 for the procedure on formatting a RAM card.
9. If you want to print the results, press **COPY**.
10. Press MAIN MENU to exit the test.

Making Channel Measurements

Composite Second
Order/Composite Triple
Beat Test

1. Select a channel, then press Main 1 of 3 **CSO/CTB**
2. Perform the following steps for analyzers both without and with Option 107 (when GATING is set to NO):
 - a. The marker defaults to the -1.25 MHz CSO beat at the lower channel boundary. Wait for the analyzer to return an answer. If your analyzer does not have Option 107 installed, turn off the carrier to measure CSO and CTB or turn off the modulation to measure CSO only.
 - b. To perform the carrier-to-beats test according to FCC requirements, remove the carrier.
 - c. Using the knob, move the marker to the desired beat, see Figure 2-17. Note that if the marker is not active you will need to press **MARKER**. Alternatively, use the NEXT BEAT key.
 - d. Press **ZOOM + MEASURE** to zoom in on the current marker position and measure the beat in a zero span sweep.
3. Perform the following steps if your analyzer has Option 107 installed and you want to perform a gated (non-interfering) measurement (CSO only with modulation turned on). Note that you will only have gotten to this point if GATING is set to NO.
 - a. Press **GATE ON/OFF** in the CSO/CTB menu to perform a gated (non-interfering) measurement.
 - b. The analyzer will search for a quiet line and depending on the setting of PAUSE it will either pause or automatically continue if it finds a quiet line. If it does not find a quiet line it will display VIDEO SYNC NOT RECOGNIZED. At this point you can remedy the reason, or if a quiet line was not found because of noise, you can press **LINE SEARCH** to reinitiate a quiet line search. Another possible reason for failure to find a quiet line is that the input coupler is not in place with its coupled leg connected to TV IN.
 - c. Entering line numbers and the key **FLD BOTH/EVEN/ODD** can be used to manually search the vertical interval for a quiet line.

NOTE

Non-interfering carrier-to-beats cannot be measured without a quiet line.

- d. Press CONTINUE to complete the measurement and display the test result on the screen.
 - e. The default marker position is at the + 1.25 MHz CSO beat. The marker can be moved using the knob or the NEXT BEATS key.
 - f. The AVERAGE ON/OFF key changes to RESTART AVERAGING for the gated test because it is done with a wide video bandwidth and testing without averaging is not meaningful. The non-gated test is done in a narrow video bandwidth.
4. Move the marker to the next beat by pressing NEXT BEAT Using the front-panel knob will also allow measuring beats other than at standard CSOICTB offsets.

Press ZOOM + MEASURE to zoom in on the current marker position and measure the beat in a zero span sweep.

The results of the measurement are displayed at the bottom of the analyzer display.

5. Press More
6. Press **ATTEN STEP DN** or **ATTEN STEP UP** to switch the attenuator to check for analyzer generated beats when not using a bandpass filter. Switch the attenuator up and down to check for changes in the beat level.

If the beat level does not change, then the beat is not generated in the analyzer. If the beat level changes with attenuator changes, then raise the attenuator setting until the beat level no longer changes. The displayed noise may prevent accurate measurement results.

Note that the personality automatically sets the attenuator to prevent analyzer generated beats upon entering the test.

Making Channel Measurements

7. Remove the carrier, or press CTB STEP UP or CTB STEP DN to measure CTB above or below the carrier (if an open space exists). Each time **CTB STEP UP** is pressed, the marker is automatically positioned at the next CTB above the carrier (+6 MHz increments). Each time **CTB STEP DN** is pressed, the marker is automatically positioned at the next CTB below the carrier (-6 MHz increments). See Figure 2-18.
8. Pressing **MORE INFO** displays the carrier-to-beat calculation. Pressing **RE-ENTER TEST** restarts the test from the beginning. Pressing **TTL PWR @ INPUT** calculates the total input power making input level adjustments more convenient. Pressing **MAIN MENU** exits the test.
9. Press **Prev Menu**
10. If you want to store the results to a RAM card, insert a formatted RAM card into the analyzer's card-insertion slot, press **(SAVE)** **display->card** , then press **(MODE)** **(MODE)** to return to channel measurement mode. Refer to Chapter 3 for the procedure on formatting a RAM card.
11. If you want to print the results, press **(COPY)**.
12. Press **MAIN MENU** The message **CHANNEL TURNED ON?** will be displayed. Be sure the channel's modulation is turned back on, then press **MAIN MENU** again.

Hints

When using a tunable bandpass filter, first peak the filter using **CARRIER LVL&FRQ** Then press **CSO/CTB** Make sure the filter bandwidth is sufficient that the 1.25 MHz beats are not rolled off.

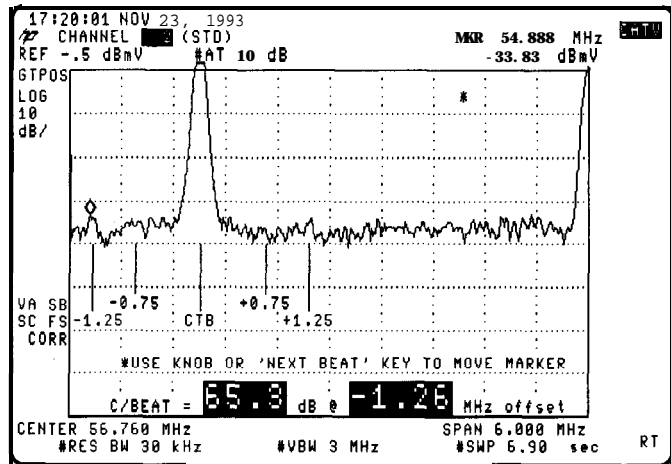

Figure 2-17. CSO Measurement

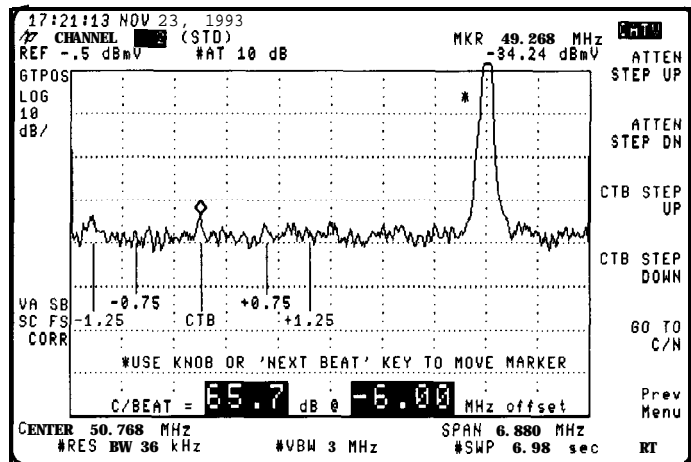

Figure 2-18. CTB Measurement

Making Channel Measurements

- Cross modulation test
1. Select a channel, turn off modulation, then press Main 1 of 3 CROSSMOD.
 2. If you want to store the results to a RAM card, insert a formatted RAM card into the analyzer's card-insertion slot, press **(SAVE)** **display** **->** **card** , then press **(MODE)** **(MODE)** to return to channel measurement mode. Refer to Chapter 3 for the procedure on formatting a RAM card.
 3. If you want to print the results, press **(COPY)**.
 4. Press MAIN MENU to exit the test.

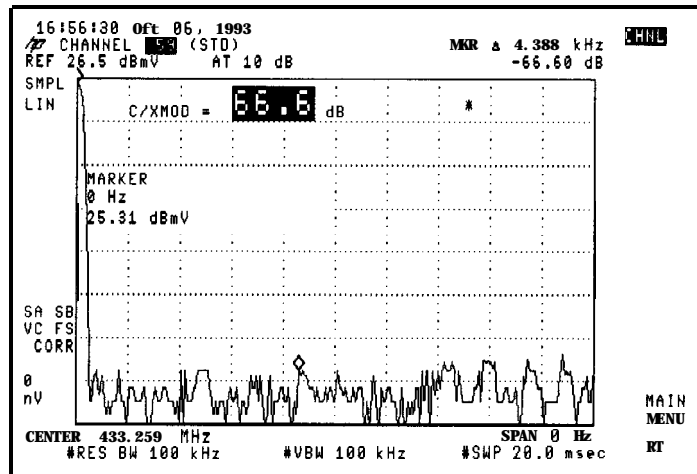

Figure 2-19. Cross Modulation Measurement

Hints

For best results, the carrier-to-noise ratio of the system should be 40 dBc or greater (in a 4 MHz noise bandwidth).

Depth of video
modulation test

1. Select a channel, then press **Main 1** of 3 **DEPTH MOD** .
2. The result is displayed at the bottom of the screen. This result is updated every 10 analyzer sweeps (approximately every 3 seconds) and continues until **STOP MEAS** or **MAIN MENU** is pressed. See Figure 2-20.

NOTE

Large amounts of hum and low frequency disturbances may affect the measurement result. If so, use TV line.

NOTE

This test must have a white level present during the vertical interval because program video may not always have white level available.

Making Channel Measurements

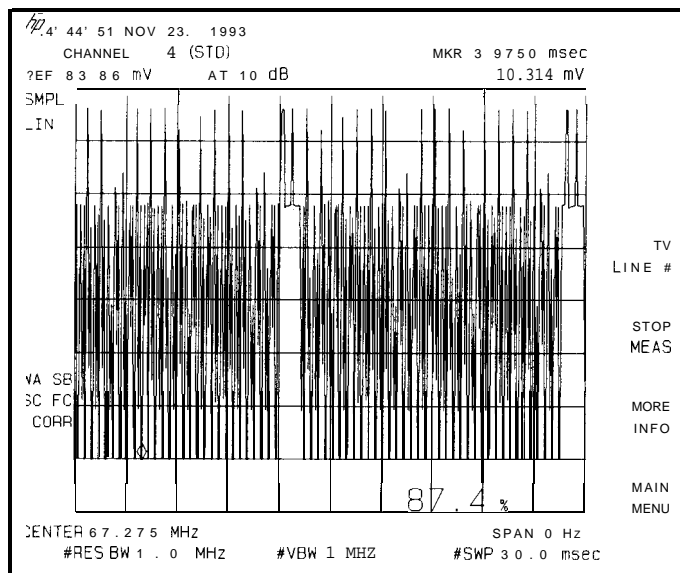

Figure 2-20. Depth of Video Modulation Measurement

3. For spectrum analyzers with TV Sync (Option 102) and Fast Time-Domain Sweeps (Option 101), the test can also be performed on an individual TV line:
 - a. Press TV LINE # . Line 17 appears as default line number.

NOTE

Options 102 and 101 are standard with the HP 8591C analyzer.

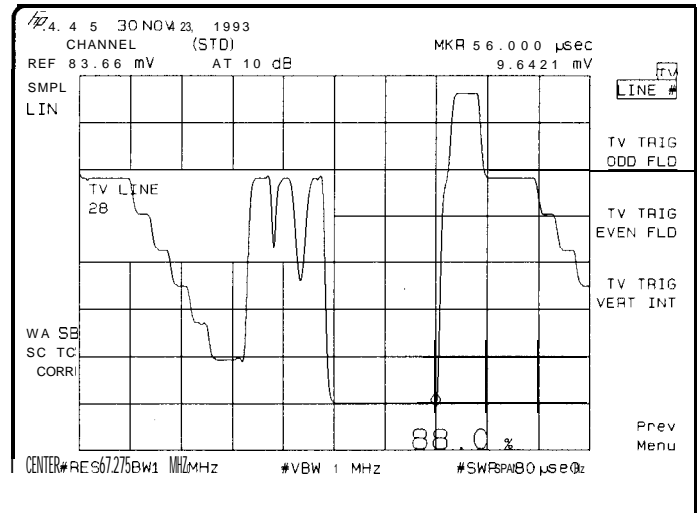

Figure 2-21. TV line Number

- b. To change the TV line number, either enter the new number and press **ENTER**, or use the up and down arrow keys (**↑** and **↓**) to increment and decrement, respectively, the current line number by one.

Video average can be used to smooth a signal by pressing the following keys:

TRACE MORE 1 of 3

VID AVG ON OFF (ON is underlined)

- c. To return to the cable TV menu, turn video average off (OFF is underlined), press Detector PK SP NG until SP is underlined, then press **MODE**, **MODE**.
- d. To view multiple horizontal lines, change the sweep time, press **SWEEP**, enter the new number and press **sec**, **ms**, or **μs**. Press the mode key twice (**MODE**, **MODE**) to return to the cable TV menu.

NOTE

The displayed video is inverted from how it would appear on a waveform analyzer (that is, sync is displayed at the top in this test and would be displayed at the bottom with a waveform analyzer).

- e. Press TV TRIG ODD FLD to change to odd field or TV TRIG EVEN FLD to change to even field.
 - f. Press TV TRIG VERT INT to trigger on both fields.
4. Press MORE INFO to display the test results, ideal value, and other measurement considerations. See Figure 2-22. Press RETURN when finished.

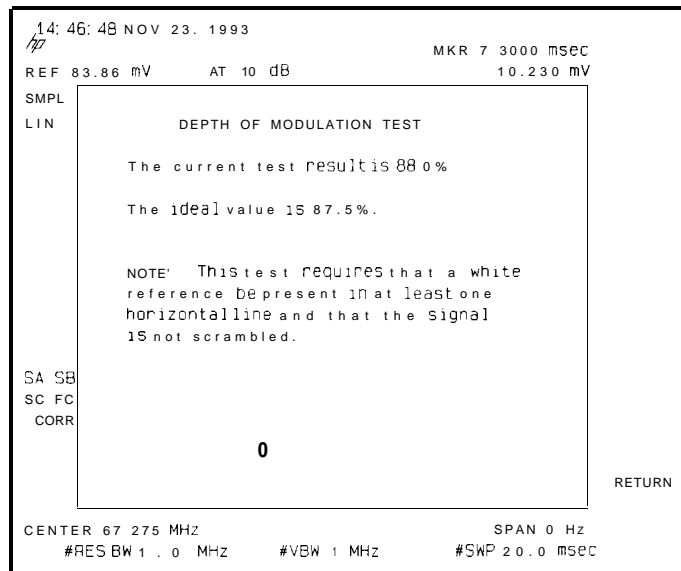

Figure 2-22. Depth of Video Modulation, More Information

5. Return to the full-field display by pressing Prev Menu
6. To stop all measurement activity, press **STOP MEAS**

At this point, the analog display mode can be activated by pressing **ANALOG+ ON OFF** in the **DISPLAY** menu. The sweep time can then be adjusted and the knob used to control the dot density to obtain the desired display. In addition, the display line and display line delta functions may be used for measuring depth of modulation. Press **DISP LINE ON** . Use the knob to place the display line on top of the horizontal sync pulses located at the top of the display. The delta display line can be activated by pressing **More 1 of 2 , DL DELTA ON OFF** .

The delta display line is then positioned at the minimum (white) level. Then the depth of modulation is displayed in the active function area. For further information about the delta display line, refer to the **DL DELTA** function description in Chapter 5.

When finished, turn **Analog+ ON OFF OFF**.

Press the mode key twice (**MODE**, **MODE**) to return to the cable TV menu.

NOTE

You cannot re-start the depth of modulation measurement after pressing **STOP MEAS** You must press **MAIN MENU**, then **DEPTH MOD** to re-start the measurement.

7. If you want to store the results to a RAM card, insert a formatted RAM card into the analyzer's card-insertion slot, press **SAVE display->card** , then press **MODE**, **MODE** to return to channel measurement mode. Refer to Chapter 3 for the procedure on formatting a RAM card.
8. If you want to print the results, press **COPY**.
9. To stop the test, press **MAIN MENU**.

Making Channel Measurements

Hints

1. For best results, the carrier-to-noise ratio of the system should be 40 dBc or greater (in a 4 MHz noise bandwidth).
2. For this measurement to work correctly, the Vertical Interval Test Signals (VITS) must include a white signal level. In addition, you may need to turn off channel scrambling.

Differential
 gain/differential phase
 test

1. Select a channel, then press Main 1 of 3 Main 2 of 3
 DIF GAIN DIF PHAZ.

NOTE

Option 107 is required for the differential gain/differential phase test.

2. The test signal is found automatically (if a test signal exists). The search starts at the default line number (line 18). If a test signal is not found, the search routine will stop at the first NTC 7 or FCC composite test signal it finds while counting down from line 22 to line 10. Figure 2-23 shows the FCC composite test signal; Figure 2-24 shows the NTC 7 composite signal.

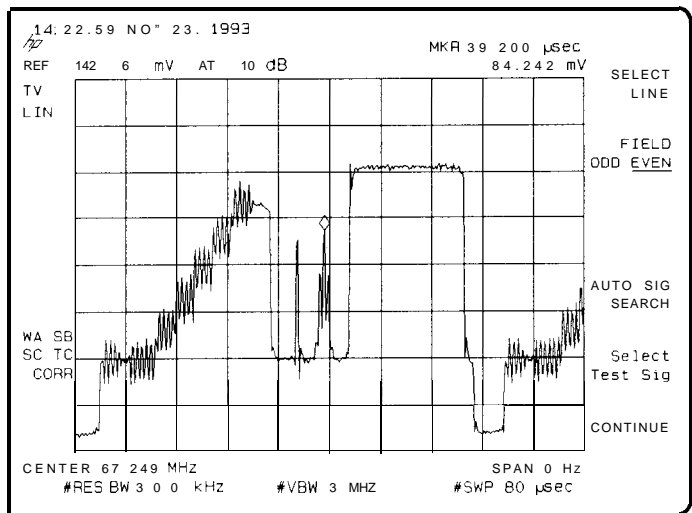

Figure 2-23. FCC Composite Test Signal

Making Channel Measurements

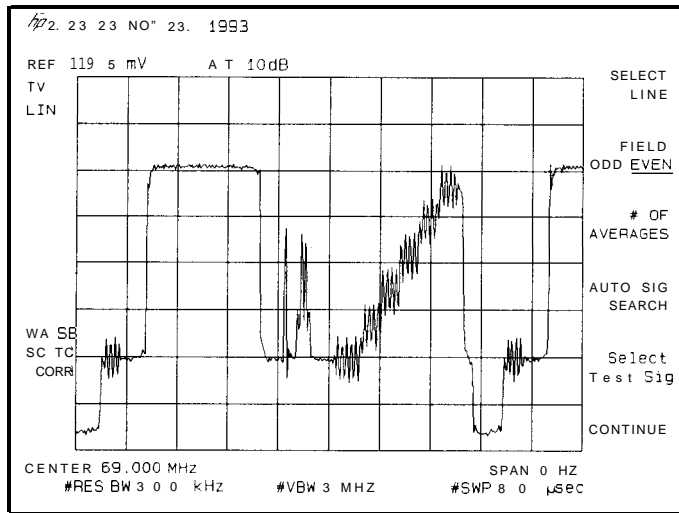

Figure 2-24. NTC 7 Composite Test Signal

NOTE

These measurements cannot be performed without a test signal containing a modulated staircase. The 5-step riser start and stop timing can affect measurement results if the timing is different from the defined standard.

Improving Accuracy

Use the External 75 Ohm Preamp (85905A) for the Differential Gain and Differential Phase tests when measuring peak visual carrier levels equal to or less than +10 dBmV. This improves the repeatability of the measurement. Repeatability is one of the components of accuracy. Accuracy is improved from 6% and 4 degrees to 4% and 3 degrees.

The external preamp must be located ahead of the coupler so the TV input can take advantage of the preamplifier's gain.

3. If the desired test signal is not displayed, press SELECT LINE then enter a line number, or press **AUTO SIG SEARCH** to execute an automatic search routine.
4. Press FIELD ODD EVEN if you need to change the field.
5. Press Select Test Sig if you need to change the test signal selection.
 - a. Press FCC COMPOSIT to select the FCC composite test signal, or NTC 7 COMPOSIT to select the NTC 7 composite test signal. To assist in test signal identification a small schematic diagram of the test signal is displayed at the top of the screen.
 - b. Press 5th PKT YES NO to determine whether the 5th riser of the staircase is included in the measurement. The default is NO (NO is underlined) and the changes are permanent until changed again by pressing this key. The status of this key is reported on the results screen just below the results box. In system mode, the 5th packet is never measured. Most modulators have 90% limiting which causes the 5th packet to be clipped on an NTC-7 composite test signal because the 5th step exceeds the white bar by more than 1.5%. Under these conditions, it is recommended that you do not use the 5th packet in your measurement. This will calculate the differential gain and differential phase result based on the reference and the first four packets.

Making Channel Measurements

- c. Press DP TEST NTC/FCC to determine whether the test meets the FCC or NTC definitions. The FCC definition of differential phase (and that of the NCTA) measures only the largest phase deviation from the phase of the reference packet. The NTC definition measures the peak-to-peak deviation of phase from that of the reference packet. The default is FCC (FCC is underlined) and changes are permanent until changed by pressing DP TEST NTC/FCC again. The status of this key is reported on the results screen just below the results box. The system mode differential phase test uses the current setting of this switch when the test plan was created. Which test was used is reported on the results table.
- d. Press **Prev** menu
6. Press # **OF AVERAGES** , enter the desired number of averages, then press **ENTER**. The default is 50 averages. The higher the number of averages, the more consistent results when measuring low level signals. This value is always returned to 50 when the test is entered.
7. Press **CONTINUE** to perform the test.

The result of the measurement is displayed on the analyzer display. See Figure 2-25.

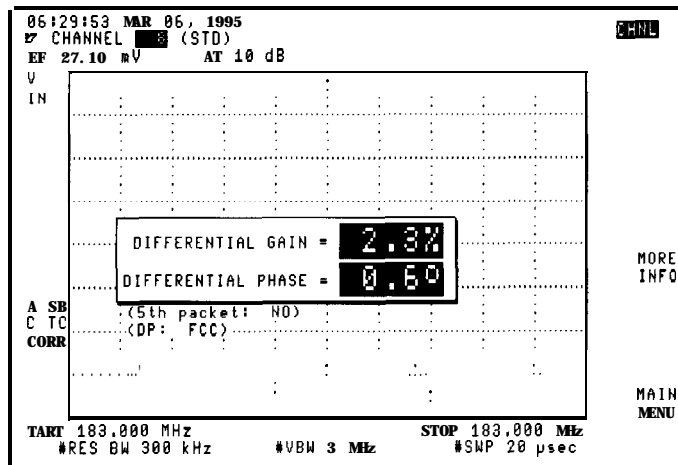

Figure 2-25. Differential Gain/Differential Phase Measurement

8. If you want to store the results to a RAM card, insert a formatted RAM card into the analyzer's card-insertion slot, press **SAVE** **display->card**, then press **MODE** **MODE** to return to channel measurement mode. Refer to Chapter 3 for the procedure on formatting a RAM card.
9. If you want to print the results, press **COPY**.
10. Press MORE INFO to display the averaged results of the individual packets. This will be useful for relative measurements. See Figure 2-26.

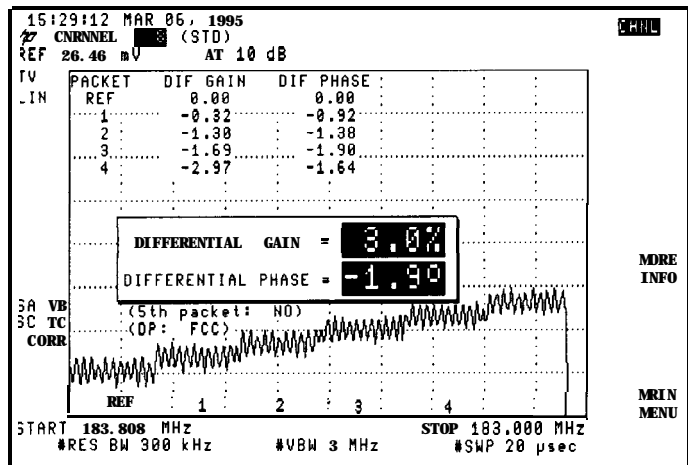

Figure 2-26. Differential Gain/Differential Phase, More Information

11. Press MAIN MENU to exit the test.

Making Channel Measurements

Digital Channel Power Measurement

The digital channel power measurement computes the total power within the specified bandwidth (between markers) of the selected channel. Before the digital channel power measurement can be accessed the channel measurement mode must be active with a channel selected.

Press the CHANNEL MEAS key in the main menu to select the channel measurement mode. Next press the CHANNEL SELECT key and enter any channel.

When tuning the channel to be measured, the channel edges must be within the display limits for accurate results. The default RBW and VBW assumes the channel bandwidth occupies at least 75% of the selected span.

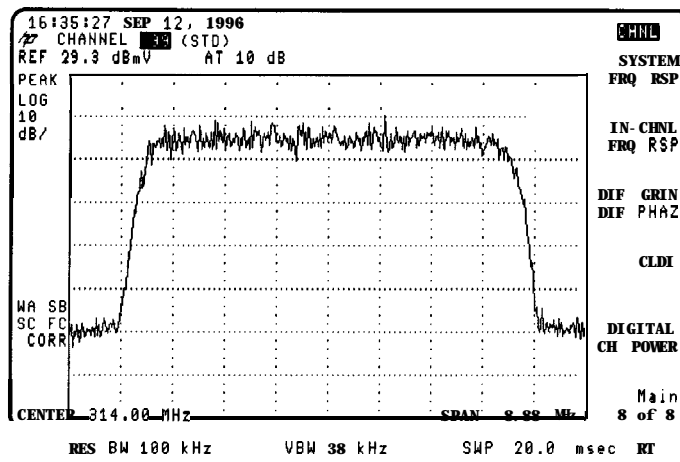

Figure 2-27. Tuned Digital Channel Display

When tuning in the channel mode, there are two methods which allow manual setting of the center frequency and span.

Method #1 - Tune by center frequency and frequency span

1. Press the **(FREQUENCY)**, CENTER FREQ and enter the center frequency setting.
2. Press the **(SPAN)** front panel key, select SPAN and enter the frequency span setting then press (Enter).

Method #2 - Tune by start and stop frequencies

1. Press the **FREQUENCY** front panel key.

2. Select **START FREQ** and enter the start frequency setting, then (Enter).
3. Select **STOP FREQ** and enter the stop frequency setting, then (Enter).

Use the **AMPLITUDE** front panel key, **REF LVL** to set the reference level so the peak of the signal falls approximately 10 to 20 dB below the top of the display.

1. Press **MODE**, **MODE** once the amplitude and frequency are set.
2. Select Menu 3 of 3
3. Press **DIGITAL CH POWER** to enter the digital power measurement.

NOTE

If you have selected **TUNE BY FRQ** in the **Tune Config** menu, the visual carrier frequency will be used as the center frequency in the channel power measurement. If you try to manually set the center frequency to a value other than the visual carrier, it will be reset to the value of the visual carrier when running the test.

The markers are automatically placed at the estimated left and right edges of the selected channel. The total power between the two markers is calculated and the result displayed in current units.

If the automatic marker placement is not ideal, the markers may be moved.

Press **MARKER 1** to change the position of the left marker.

Press **MARKER 2** to change the position of the right marker.

The marker frequency position may be entered directly using the numeric keypad or adjusted using the knob control and step keys.

Making Channel Measurements

NOTE

If the left marker is placed to the right of the right marker, the message "MKR 2 > MKR 1?" is displayed. The measurement will not be performed until the markers are repositioned properly

Use the AVERAGE key to turn averaging on or off. When averaging is enabled the previous measurement result is erased.

Use the # OF AVERAGES key to set the number of sweeps to be averaged to produce the final result. The input range is from 1 to 999 and the default is 10.

If averaging is off, the total power is recalculated and displayed automatically at the end of each sweep. With averaging on, the result is displayed after the number of specified sweeps have been reached. All results are displayed in current measurement units,

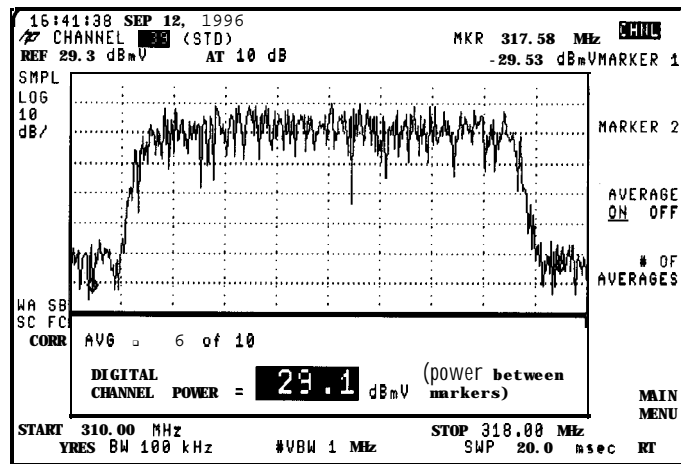

Figure 2-28. Results of Digital Channel Power Test

NOTE

The analyzer has been configured for maximum accuracy. Adjustment of VBW or RBW may degrade the measurement performance.

Press MAIN MENU to exit the test.

FM deviation test

NOTE

Option 102 or 301 is required to perform the FM deviation measurement using HP 8590 E-Series spectrum analyzers. This option is standard with the HP 8591C analyzer.

1. To use the FM deviation function, press FM DEV . The markers are placed on the largest peak-to-peak extreme found during the measurement time.
2. If desired, change the number of cycles per measurement by pressing CYCLES/MSMT . The default is 25 cycles per measurement.
3. If you want to store the results to a RAM card, insert a formatted RAM card into the analyzer's card-insertion slot, press (SAVE) **display->card** , then press **MODE** **MODE** to return to channel measurement mode. Refer to Chapter 3 for the procedure on formatting a RAM card.
4. If you want to print the results, press (COPY).
5. Press MAIN MENU to exit the test

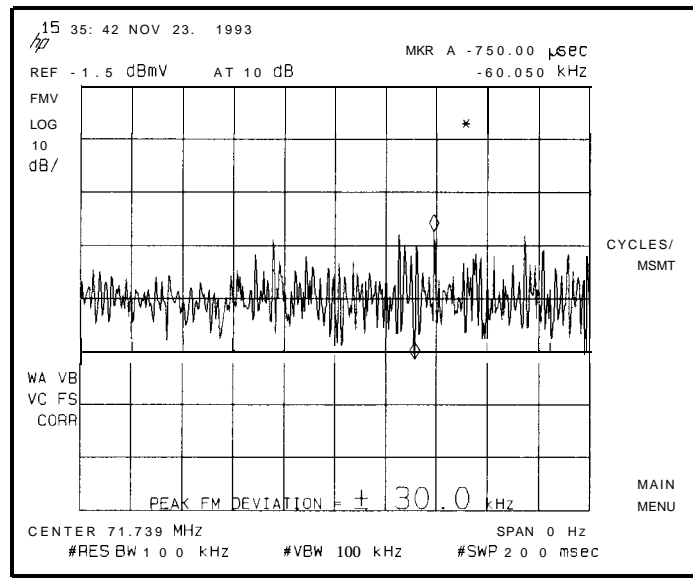

Figure 2-29. FM Deviation

Hum test

1. Select a channel or tune directly to the carrier to be measured. Make sure that the desired carrier is the highest on screen by adjusting the center frequency and/or span as needed. Turn off modulation (optional), then press Main 1 of 3 , HUM. See Figure 2-30.

Video Modulation Present

Note that after pressing HUM , the first thing the analyzer does is determine if video modulation is present. If the video modulation is found to be on and the test result is greater than 3 percent, an additional message appears advising the operator to re-test using a CW signal only

2. Pressing MORE INFO results in the analyzer performing a single sweep of 800 ms and performs a Fast Fourier Transform (FFT) on it to separate power line related components. See Figure 2-31.
60 Hz, 120 Hz, 180 Hz, and 240 Hz are displayed. This is intended to be used as a troubleshooting aid. A relatively high 60 Hz level implies inadequate grounding or stray power utility neutral currents. A relatively high 120 Hz level implies poor filtering of a full-wave rectifier in a power supply.
3. If you want to store the results to a RAM card, insert a formatted RAM card into the analyzer's card-insertion slot, press **SAVE** **display->card** , then press **(MODE)** **(MODE)** to return to channel measurement mode. Refer to Chapter 3 for the procedure on formatting a RAM card.
4. If you want to print the results, press **(COPY)**.
5. Press MAIN MENU to exit the test.

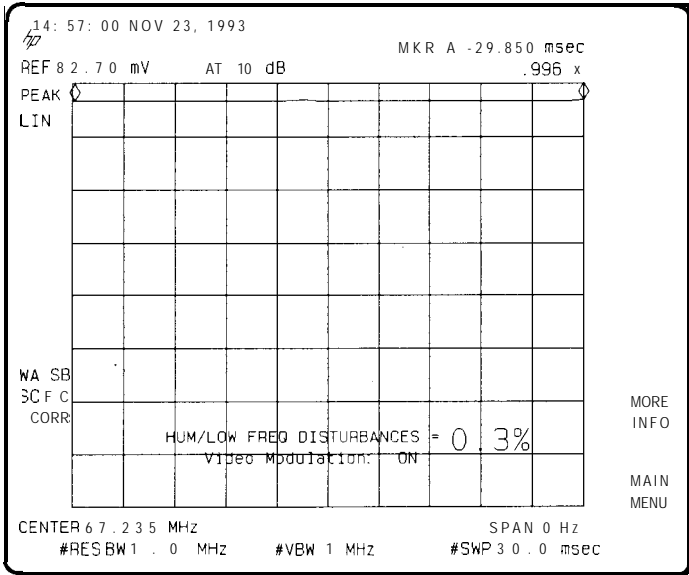

Figure 2-30. Hum Measurement

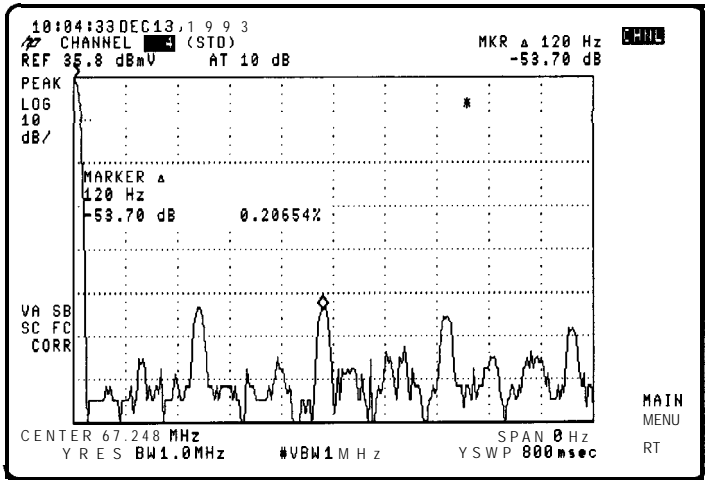

Figure 2-31. Hum, More Information

Making Channel Measurements

Hints

1. For best results, the channel carrier-to-noise ratio should be 40 dB or greater (in a 4 MHz noise bandwidth).
2. The hum test requires a carrier wave or NTSC signal. It cannot give meaningful results when a channel uses sync suppression scrambling (unless the measurement is made at the subscriber terminal output of a **descrambler**). Measuring hum with video modulation present requires that all sync tips have the same general level in order to measure their variation.

When the hum test is performed on channels with sync suppression scrambling, it gives completely meaningless numbers.

In-channel frequency
response test

1. Select a channel, then press **Main 1** of 3 **Main 2** of 3
IN-CHAN FRQ RSP.
2. Press **SWP TEST SETUP** if you will be using a manually swept signal or line sweep as a test signal. See Figure 8-16. This setup puts Trace A into max hold with 2 markers and with Trace B active.
 - a. After Trace A achieves sufficient data, the markers can be placed on the peak and the valley using the keys **MARKER 1** and **MARKER 2**
 - b. Pressing **CALC FRQ RESP** calculates the frequency response using the positions of the 2 markers.
 - c. Pressing **RESTART MAX HOLD** resets Trace A.

Hints

- a. Press the **(NEXT) (HOLD)** key to clear the active area to make markers more visible if placed there.
- b. Try using line sync when the sweep signal is sweeping at a rate near the vertical sync rate. Press **TRIG, LINE**.

3. If Option 107 is installed, press **VITS TEST** to select a vertical interval test signal for testing.
 - a. The analyzer automatically defaults to line number 19. An appropriate test signal may or may not be present at this line number. Test signals can be GCR, FCC multiburst, NTC 7 combination multiburst, or sin x/x. Refer to Figure 2-32, Figure 2-33, Figure 2-34, and Figure 2-35.

NOTE

Test signals for in-channel frequency response measurements must be found and selected manually. Multiburst and NTC 7 combination frequency packet pulse widths are critical to measurement results.

- b. To change the line number, either enter the new number and press **ENTER**, or use the **↑** or **↓** arrow keys to increment and decrement, respectively, the current line number by one.
 - c. Press **FLD BOTH EVEN ODD** to change the field as required.
 - d. Press **Select Test Sig** to select the displayed test signal. The selections are **GCR** (Ghost Cancellation Reference), **MULTI-BURST** (FCC multi-burst), **NTC-7 CMBNTN** (NTC-7 combination multi-burst), or **SIN X/X** (sine x/x). Refer to Figure 2-32, Figure 2-33, Figure 2-34, and Figure 2-35.
4. Press **CONTINUE** to execute the measurement. The peak and valley in the measurement range will be found and used to calculate the result. See Figure 2-36 and Figure 2-37. Pressing **MARKER 1** or **MARKER 2** allows manual placement of the markers. After either of these keys is pressed, the automatic peak-to-valley search is stopped so the markers stay where they are manually placed.
 5. Press **MORE INFO** to display the marker amplitudes. See Figure 2-38.
 6. Press **MAIN MENU** to exit the test.

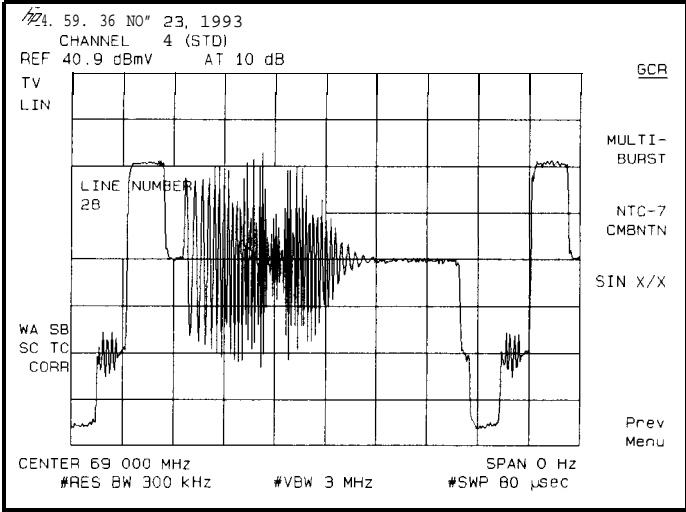

Figure 2.32. Ghost Cancellation Reference (GCR)

NOTE
The function that views test signals is intended for signal identification only. Significant signal distortion and high frequency roll-off does not affect the actual measurement.

Making Channel Measurements

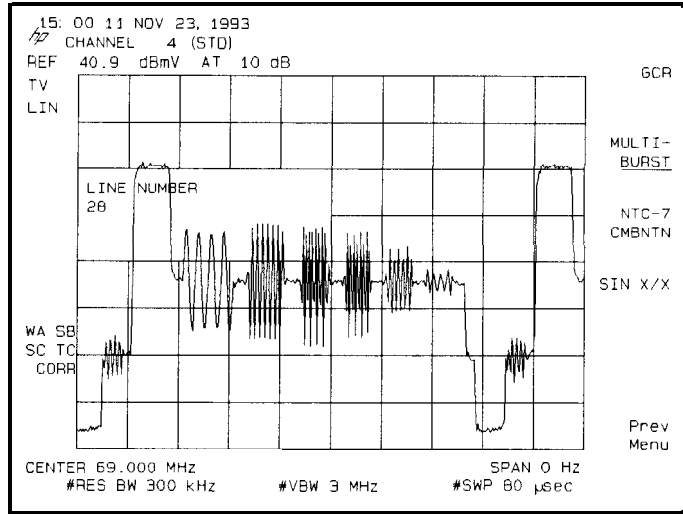

Figure 2-33. FCC Multi-Burst Test Signal

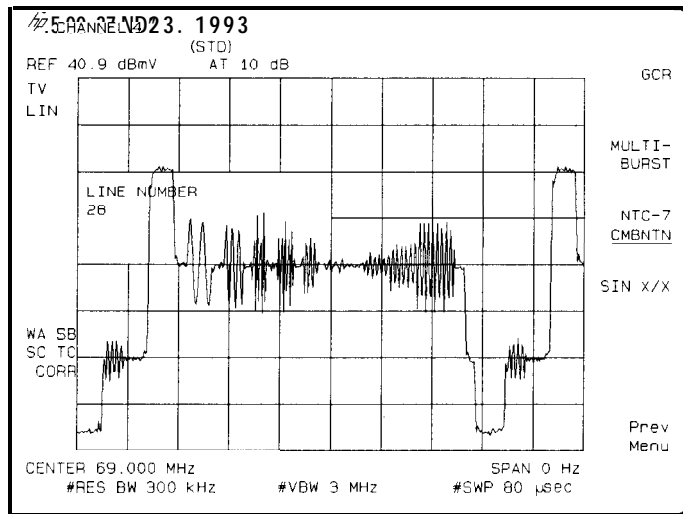

Figure 2-34. NTC-7 Combination Multi-Burst Test Signal

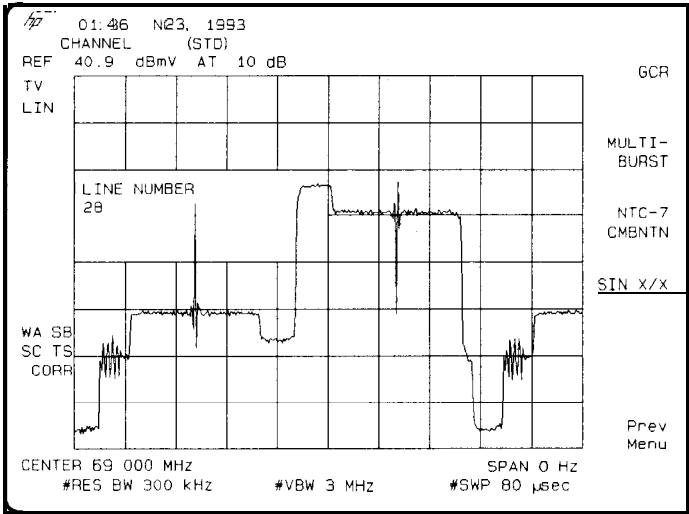

Figure 2-35. Sine XIX Test Signal

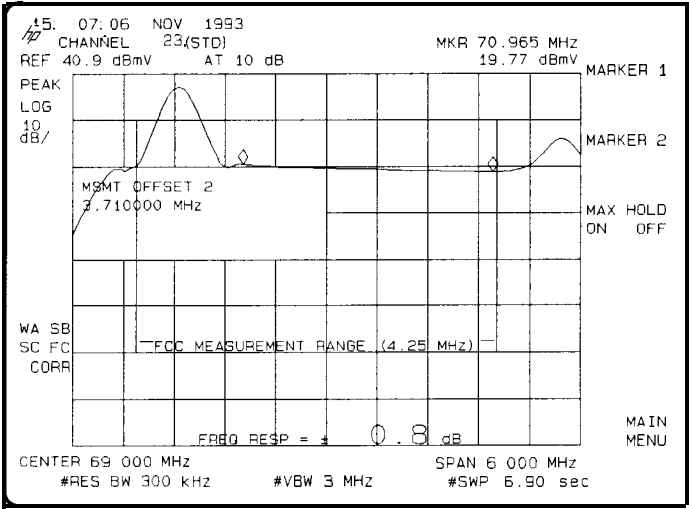

Figure 2-36. Results with GCR or line Sweep Test Signal

Channel Measurements
Making Channel Measurements

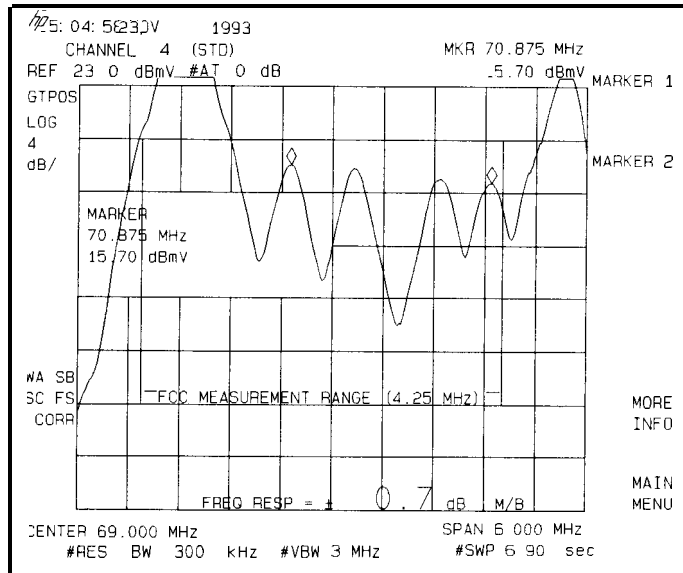

Figure 2-37. Results with FCC Multi-Burst Test Signal

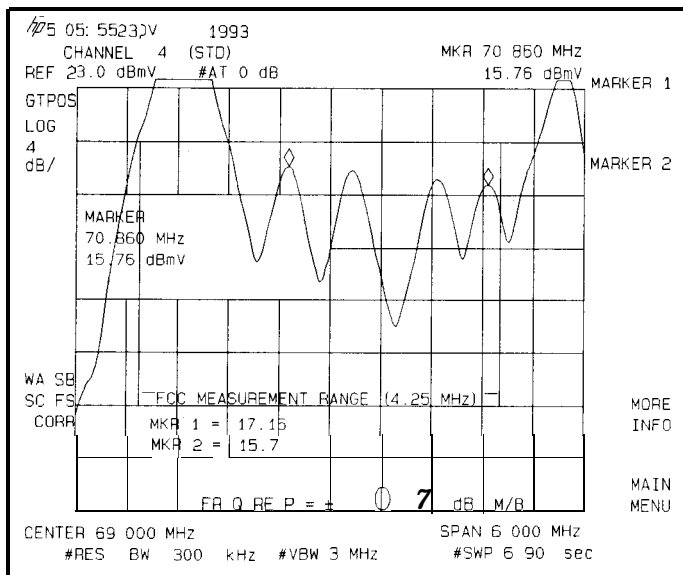

Figure 2-38. More Information (Multi-Burst)

System frequency
response test

1. To perform a cable TV overall system frequency response, press the following analyzer keys:

Main 1 of 3 Main 2 of 3

SYSTEM FRQ RESP

2. Press ENTER STRT FRQ , enter the start frequency of your system, then press **ENTER**.
3. Press ENTER STOP FRQ , enter the stop frequency of your system, then press **ENTER**.

NOTE

The start and stop frequencies for the measurement should be the same as the reference trace for meaningful results.

4. If you want to use a reference trace that was previously stored in the analyzer's internal memory and you know the trace register number of the reference trace, press RECALL FRM INT . See Chapter 5 for more information about using RECALL FRM INT
5. If you want to create a reference trace, press CONTINUE , TAKE REF TRACE See Chapter 5 for more information about using TAKE REF TRACE.
6. After the reference trace appears on screen, select FAST SWEEP or SLOW SWEEP , then, if you want to save the reference trace, press SAVE TRB TO INT , enter a register number, then press **ENTER**.
7. Press DO FRQ RESP TST to perform the measurement. See Figure 2-39. Also, see Chapter 5 for more information about using DO FRQ RESP TST

Making Channel Measurements

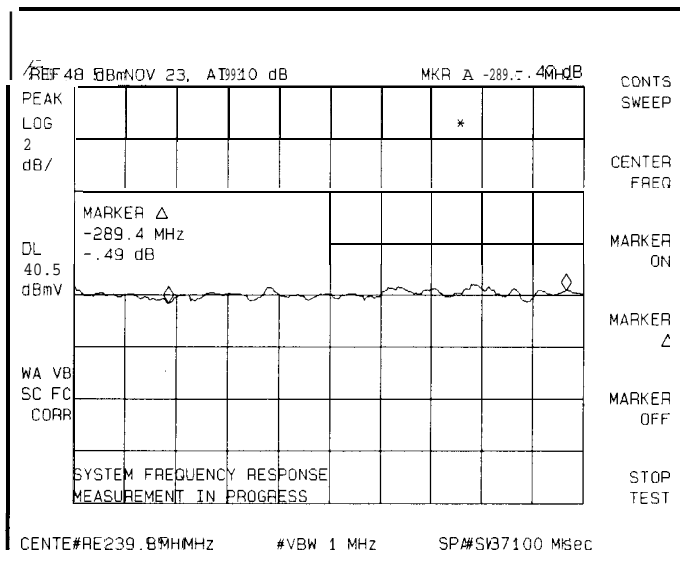

Figure 2-39. System Frequency Response Measurement

8. Press CONTS SWEEP for continuous sweep, or to restart the sweep.
9. Press CENTER FREQ to specify the center frequency. This is not normally needed but is useful to fine adjust the measurement data relative to the reference data to minimize ripple.
10. Press MARKER ON to turn the marker on.
11. Use MARKER A to determine the difference in frequency and amplitude relative to the first marker position.
12. Press MARKER OFF to turn marker off.
13. Press STOP TEST to stop the measurement.
14. Press Prev menu MAIN MENU to exit the test.

**Procedure for System
Flatness Measurement**

The following is an outline for measuring system flatness using two points in the system. For example, a reference trace could be taken at the headend, then compared to a flatness measurement made somewhere out in the system.

1. Take a reference trace at point A as previously described (for example, at the headend or first trunk amplifier).
2. Go to point B and make a measurement. The result is the difference between points A and B.
3. Use the FAST SWEEP function for real-tune amplifier adjustments.
4. Use the SLOW SWEEP for the most accurate results when scrambled channels are present.

View ingress test

1. Select a channel, then press **VIEW INGRESS**. A marker is placed on the peak of the carrier, and the delta marker is activated.
2. After the displayed modulation and noise are reduced with minimum hold, use the knob to position the delta marker on a signal appearing above the noise. The frequency and amplitude differences between the peak carrier level and the marker appear in the active function block. See Figure 2-40.

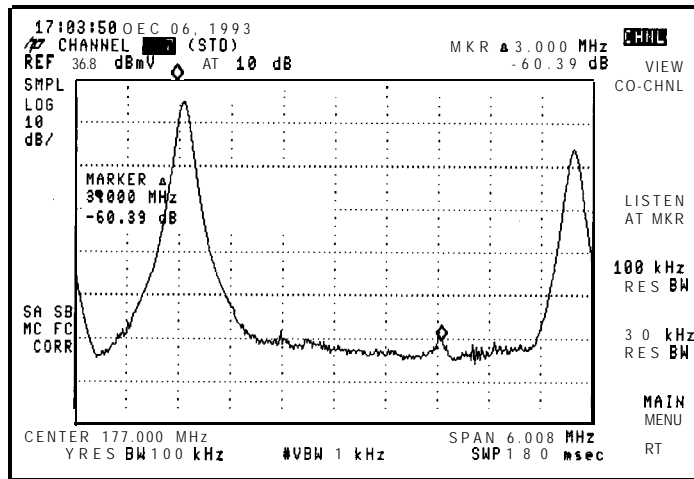

Figure 2-40. View Ingress

3. During the test, you can change the default 100 kHz resolution bandwidth (RBW). For example, you might select 30 kHz RES BW to improve resolution of signals close to the visual carrier. Return to 100 kHz RBW by selecting 100 kHz RES BW

Selecting either resolution bandwidth resets the minimum hold function used in the test to improve viewing of ingress.

4. Demodulate the ingress signal in AM or FM by pressing the **LISTEN AT MKR** then **DEMOD AM FM**. Press **LISTEN OFF** to return to the previous menu.
5. Press **VIEW CD-CHNL** to set the analyzer to see co-channel interference. See Figure 2-41. Also, see Chapter 5 for more information about **VIEW CO-CHNL**

6. Press MAIN MENU to exit the test.

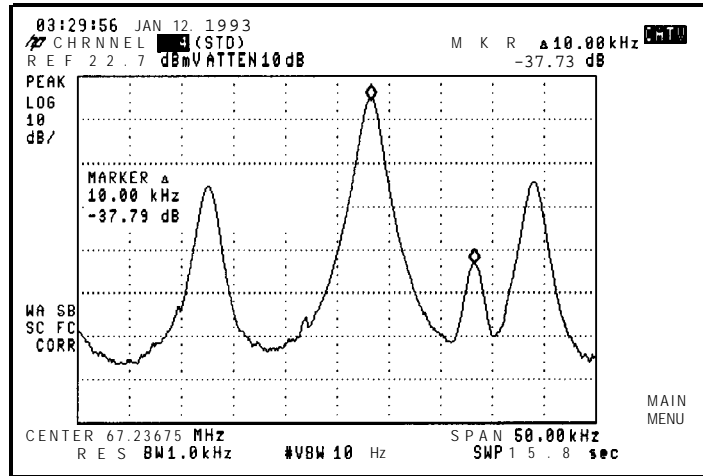

Figure 2-41. View Co-Channel Measurement

NOTE

Because of the minimum hold function used in this measurement, the delta marker display is approximately 3 dB lower than the actual signal level. For example, if the marker displays -50 dBc, the actual signal level is closer to -47 dBc.

Step 4. Access the spectrum analyzer mode

1. Press the desired spectrum analyzer front panel hardkey function

or
2. Press (PRESET).
3. To use the spectrum analyzer operating mode while in the cable TV analyzer operating mode, select a front-panel hard key (for example AMPLITUDE, FREQUENCY), then make adjustments and measurements as needed. Then, press MODE MODE to return to the cable TV analyzer operating mode.

When the analyzer is in the spectrum analyzer operating mode, CHNL is no longer displayed in the upper right corner of the analyzer display.

Step 5. Access the TV receiver mode (optional)

1. Press **MODE**, **TV RECEIVER**,
2. Press **CHANNEL SELECT** , enter the channel you want to view with the numeric keypad, then press **ENTER**. You can also select channels by using the large knob or arrow keys on the front panel.
3. Press **PIX &SND ON OFF** to turn the picture and sound on.
4. Adjust the volume and intensity knobs for the desired volume level and picture intensity.
5. To exit TV picture and sound, press any of the following: **WINDOWS ON**, **AUX CTRL**, **MODE**, or any softkey.
6. Additionally, the TV picture and sound can be accessed from within the channel measurements mode by pressing **WINDOWS ON**.
7. Channels can then be selected with the numeric keypad, then pressing **ENTER**. You can also use the knob or arrow keys for channel selection.
8. To exit TV picture and sound, press any of the following: **WINDOWS ON**, **AUX CTRL**, **MODE**, or any softkey.
9. To exit this mode press Prev Menu

NOTE

Option 107 is required to access TV receiver mode.

Channel Measurements

Making Channel Measurements



———— System Measurements

System Measurements

What You'll Find in This Chapter

This chapter describes how to make cable TV measurements using the system measurements mode of operation (SYSTEM **MEAS**). This chapter contains the following sections:

- making system measurements
- making timed system measurements
- creating a test plan
- editing the current test plan
- clearing the current test plan
- cataloging analyzer memory
- recalling a test plan from a RAM card
- recalling test data from the RAM card
- cataloging a RAM card
- formatting a RAM card
- deleting all the files from a RAM card
- deleting individual ELES from a RAM card

The following tests can be performed in SYSTEM **MEAS** mode:

- visual/aural carrier levels
- visual/aural carrier frequencies
- depth of modulation
- hum[†]
- CSO[†] *
- carrier-to-noise ratio
- DG, DP, CLDI[†] *
- in-channel frequency response[†] *
- FM deviation

If a test fails in the SYSTEM **MEAS** mode, confirm the failure using

CHANNEL **MEAS** mode. This may involve disabling carriers or modulation according to FCC rules. Relative measurements showing cable TV equipment contributions may also be helpful in meeting FCC requirements.

[†] Cannot perform on scrambled channels.

* Option 107 required.

Making System Measurements

The system measurement mode of operation allows you to create and save test plans that contain the following setup information:

- channel numbers
- tests to run
- scrambling status

If Option 107 is installed:

- vertical interval test signal (VITS)
- VITS line number
- Eeld-odd, even, or both

NOTE

Appropriate vertical interval test signals (VITS) must be present for meaningful results in Option 107 based tests. Advertisement insertion equipment may cause these signals to be deleted during their active time.

Once all test plans have been created and saved to internal memory or RAM card, the measurement process is a simple six step operation:

1. Configure the test system.
2. Connect the signal to the analyzer.
3. Enter the location code.
4. Enter the temperature.
5. Recall a test plan from internal memory or RAM card.
6. Make the measurement (select between immediate or timed measurements).

Optional steps include accessing the spectrum analyzer mode and accessing the TV receiver mode (Option 107 required).

Step 1. Configure the test system

The Setup menu is used to set up channel tuning, a user defined channel, an external preamplifier, and an external matching pad (50 Ω analyzers only).

The information is stored in nonvolatile analyzer memory. This means that the analyzer retains the information, even when power is turned off, until you access the Setup menu again and change it.

1. If the Setup softkey is displayed, press it now. Otherwise, press **MODE**.
CABLE TV ANALYZER Setup.
2. Press Channel Tuning, then press STD AIR HRC IRC T until the desired format is underlined.

The tune configuration menu allows you to select channel format:

- STD-Standard Cable
 - AIR-Broadcast Channel
 - HRC-HRC Cable
 - IRC-IRC Cable
 - T-Upstream Channels
3. Press Prev Menu to return to the main menu.

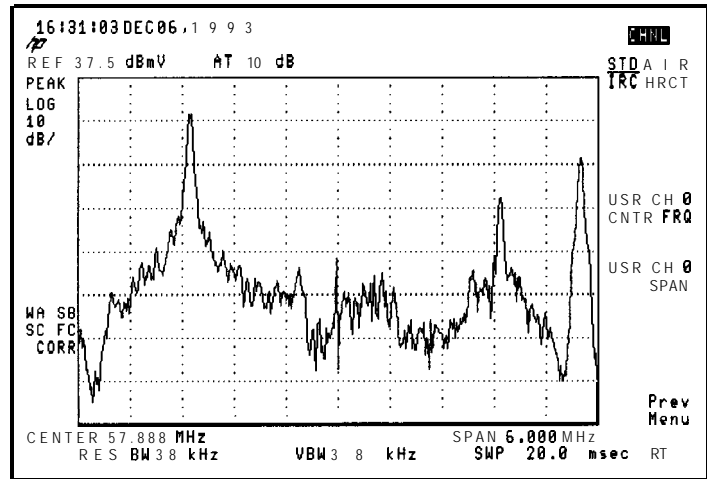

Figure 3-1. Channel Tuning Menu

4. For spectrum analyzers with a 50 Ω input: Use an external 50 Ω to 75 Ω matching pad/dc block to compensate for the impedance mismatch between a 75 Ω impedance system and the spectrum analyzer's 50 Ω input impedance. If you use an HP 11981A external pad, the external pad causes approximately 5.8 dB of amplitude loss. The external pad function (EXT PAD YES NO) can be used to compensate for this amplitude loss.

- Connect the matching pad to the spectrum analyzer input.
- Press Analyzer Input EXT PAD YES NO to underline YES.
- Press Prev Menu to return to the Setup menu.

If you are using a spectrum analyzer with 50 Ω input impedance but are not using an external matching pad/dc block, the analyzer will compensate for most of the impedance mismatch, but amplitude measurements can have up to ± 0.2 dB additional error caused by the uncompensated mismatch over the frequency range.

CAUTION

dc voltages in excess of 25 V and ac power-line voltages in excess of 100 V_{peak} can permanently damage the analyzer input.

5. For **using an external amplifier (preamp)**: An external amplifier may be required for the carrier-to-noise test. See Chapter 8 for more information about when a preamplifier is required for the carrier-to-noise test. The carrier-to-noise test calculates the noise contribution of the external amplifier and reports that correction on the MORE INFO screen of the carrier-to-noise test.

- Connect the output of the external amplifier to the analyzer input (or input of coupler).
- Connect the cable TV signal to the input of the external amplifier.
- Press Analyzer Input EXT AMP YES NO to underline YES.
- Press EXT AMP GAIN then enter the gain value of the external amplifier. The default value is 20 dB for the HP 85905A preamplifier.
- Press EXT AMP NZ FIG then enter the noise figure value of the external amplifier. The default value is 7 dB for the HP 85905A preamplifier.
- Press **Prev** Menu to return to the Setup menu.

The TOTL PWR @ INPUT function measures the total RF power into the analyzer. Use this function to externally adjust the total power into the analyzer or preamplifier for optimization of measurement dynamic range.

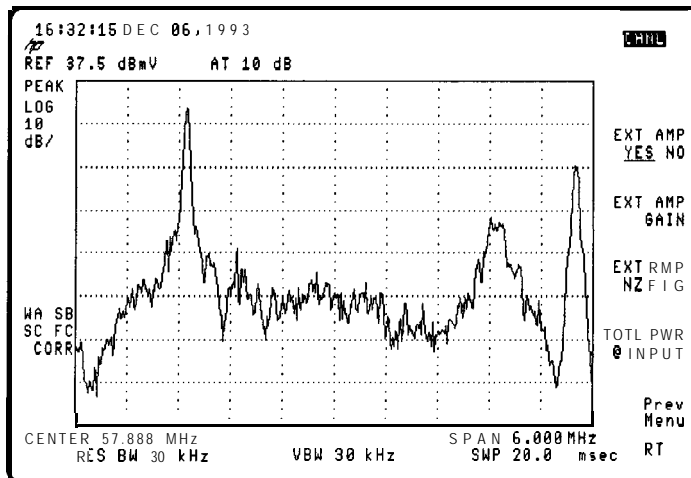

Figure 3-2. Analyzer Input Configuration Menu

6. If the system CSO/CTB test is desired, specify a channel to be tested. Press **System Beats** , **SYS BTS TST CBNL** , then enter the channel number.

The default is channel 4. The default measurement frequency for CTB is 6 MHz above the visual carrier. The default measurement frequency for CSO is 4.75 MHz above the visual carrier. The results will appear on the first page of the measurement data.

If you want to change the offset for CTB and CSO relative to the channel selected with **SYS BTS TST CHNL** , press **CTB FREQ OFFSET** , enter the frequency offset for measuring CTB from the carrier, then press **ENTER** . Similarly, press **CSO FREQ OFFSET** , enter the frequency offset for measuring CSO from the carrier, then press **ENTER** . Entering an offset as negative will allow measurements below the channel's visual carrier. Ensure that the measurement locations are "in the clear" relative to the **SYS BTS TST CHNL**

7. Connect the cable TV signal as shown in "Step 2. Connect the signal to the analyzer. "

Step 2. Connect the signal to the analyzer

CAUTION

To prevent the analyzer input from being damaged, the total power at the analyzer input must be less than +72 dBmV.

To prevent the analyzer input mixer from being overloaded, the total power at the analyzer input mixer must be less than +37 dBmV, except for CSO/CTB for which +27 dBmV is the maximum total power input to the mixer. For systems with unequal carrier levels (system tilt), the total power must be calculated by summing the individual carriers. The **TOTL PWR** **Ⓢ** **INPUT** softkey function accounts for system tilt.

You can measure the input power by pressing **Setup** , **Analyzer Input** , **TOTL PWR** **Ⓢ** **INPUT** The total power is displayed at the bottom of the screen.

Total power at the input mixer can be reduced by increasing input attenuation. Press **(AMPLITUDE)** **ATTEN** , and make the adjustment. The analyzer retains a manually selected attenuation until you either select a new value or reset the analyzer power-on default conditions.

For all tests provided by the HP 85721A personality, the analyzer automatically selects the attenuator setting to meet the above requirements.

1. Use the necessary adapters to connect the cable TV signal to the analyzer. See Figure 3-3.
2. If your analyzer has Option 107 installed, you must use the coupler (provided) and connect the cable TV signal to the TV IN and analyzer input connectors as shown in Figure 3-4. Figure 3-4 shows the connections for RF and video measurements.
3. If your analyzer has Option 107 installed, ensure that the rear-panel TV TRIG OUT is connected to GATE IN as shown in Chapter 1.

NOTE

The TV IN connector on the HP 8591C analyzer with Option 107 is located on the front panel. However, on HP 8590 E-Series spectrum analyzers with Option 107, the TV IN connector is located on the rear panel.

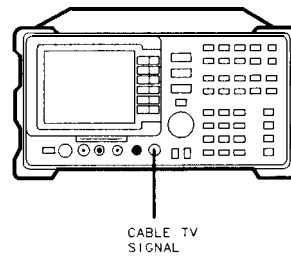

p176a

Figure 3-3. Connecting the Cable to the Input Connector

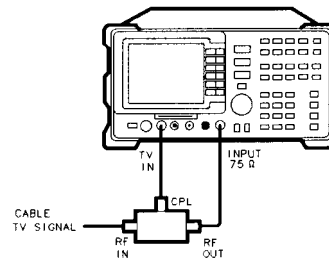

p177a

Figure 3-4. Connections for HP 8591 C analyzer with Option 107 (RF Measurements)

Hints

You can return to the system measurements softkeys by pressing **MODE**, **MODE**.

Step 3. Enter the location code

1. Press **SYSTEM MEAS**
2. Press **ENTER LOCATION**.
3. Press the data keys to enter the location code. The location code can be up to seven digits long. If you make a mistake, you can use the back space key to correct the location code. The back space key (**BK SP**) is on the lower right corner of the analyzer's front panel, next to the **ENTER** key.
4. Press (**ENTER**) when the location code has been entered.

ENTER LOCATION allows you to enter a location code. The location code is only for your convenience; it is meant to help you keep track of where the data originated. The location code you enter will be stored and printed with the data.

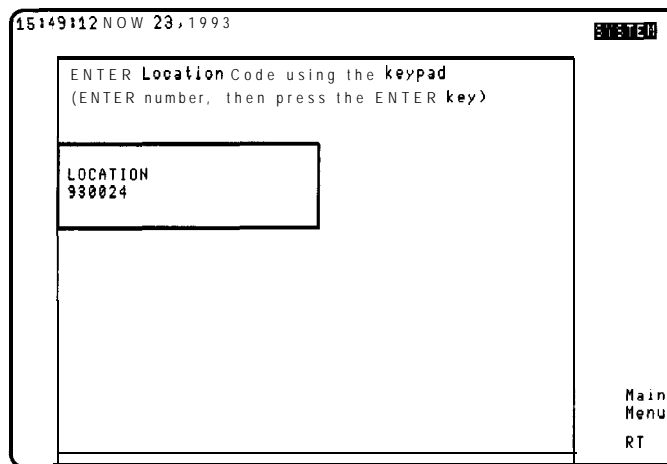

Figure 3-5. Enter location Menu

Step 4. Enter the temperature

1. Press ENTER TEMP
2. Press the data keys to enter the temperature. If you make a mistake, you can use the back space key to correct the location code. The back space key (**BK SP**) is on the lower right corner of the analyzer's front panel, next to the **ENTER** key.
3. Press **ENTER** when the temperature has been entered.

ENTER TEMP allows you to enter the ambient temperature without the Celsius or Fahrenheit units. This function is only for your convenience; it is not necessary to enter the temperature when making a measurement. The temperature you enter will be stored and printed with the data. (The analyzer does not measure the temperature; you must provide the temperature reading.)

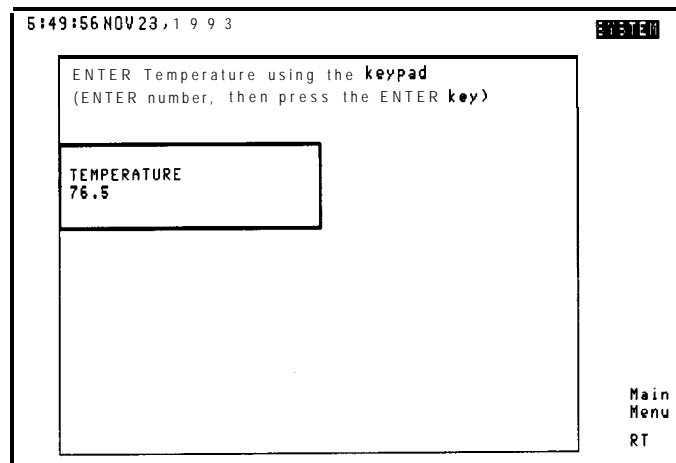

Figure 3-6. Enter Temperature Menu

Step 5. Recall a test plan

1. Press Recall **TstPlan**.
2. Press RECALL FRM INT to recall a test plan from the analyzer's internal memory, or RECALL FRM CARD to recall a test plan from a RAM card.

NOTE

If you have not created a test plan, refer to "Creating a Test Plan" later in this chapter.

3. If you selected RECALL FRM INT, select the test plan number under which the test plan was saved, then press DONE.

For example, if the test plan was saved under test plan 1, press PLAN 1

You can recall a test plan that was previously saved in analyzer memory. Recalling a test plan will overwrite the current test plan. If you do not want the current test plan overwritten, save the current test plan before recalling a test plan. See "3. Save the current test plan in internal memory" in this chapter for more information.

For information on recalling a test plan from a RAM card, refer to "Recalling a Test Plan from a RAM Card" later in this chapter.

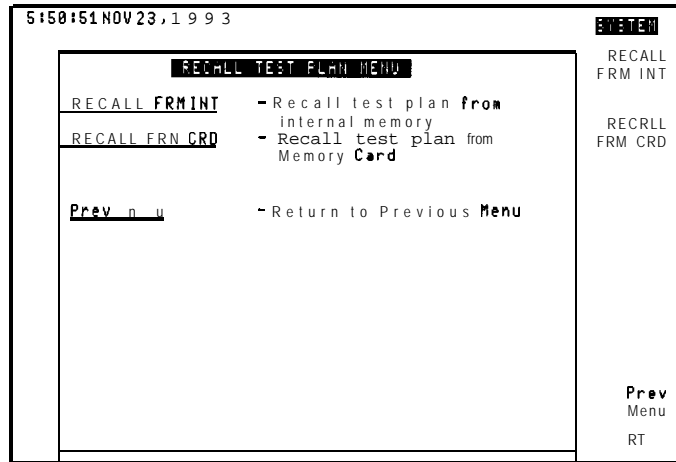

Figure 3-7. Recall from Internal Analyzer Memory

Step 6. Make the measurements now

This procedure describes how to initiate immediate testing. For information on making measurements at a later time, refer to “Making Timed System Measurements” later in this chapter.

1. Press Measure **Now**
2. Press Yes if you want to measure system CTB/CSO or No if not. If Yes is selected, system CTB/CSO will be measured using the channel specified using the SYS BTS TST CHNL softkey located in the Setup menu. The default is channel 4. System CTB will be measured using the offset specified by the **CTB FREQ OFFSET** softkey located in the Setup menu. The default value is 6 MHz above the test channel’s visual carrier. System CSO will be measured using the offset specified by the **CSO FREQ OFFSET** softkey located in the Setup menu. The default value is 4.75 MHz above the test channel’s visual carrier,

Alternatively, set the SYS BTS TST CHNL to the highest channel in the system. If there are no signals just above the top channel, set the CSO FREQ OFFSET to 7.25 MHz. These settings will measure the CTB and + 1.25 MHz CSO beats in the clear just above the top channel. If there are signals just above the top channel, such as digital music signals, add increments of 6 MHz to the CTB and CSO offsets until a spot in the clear is found. However, going too far into roll-off can compromise the measurement results.

3. You can select whether results are to be printed (if you have a printer connected to the analyzer), stored on a RAM card, or sent to the screen:
 - a. If you want the data sent to the screen, press DUMP to SCREEN

- b. If you want the data printed, press DUMP to PRINTER . For information about connecting the printer to the analyzer, see “Step 3. Install a printer,” located in Chapter 1.
- c. If you want the data to be saved on a RAM card, insert a RAM card in the card reader, ensure that the RAM card has been formatted and the write-protect switch is set so the RAM card is not write protected, then press DUMP TO RAM CARD

See “Formatting a RAM Card” later in this chapter for information about formatting a RAM card.

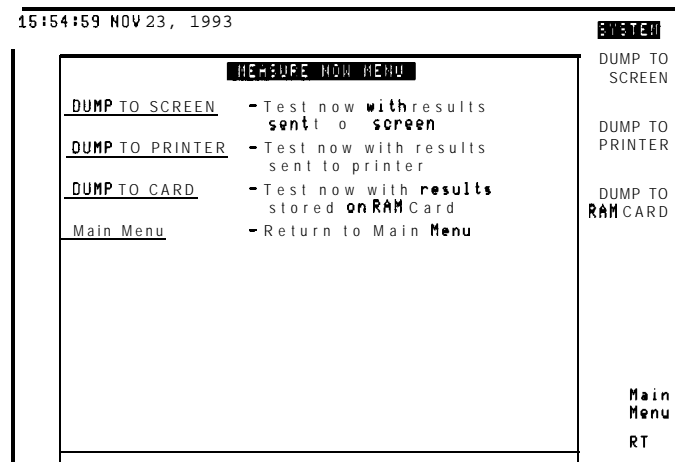

Figure 3-8. Dump Options Menu

- 4. If you want to stop the testing, press ABORT . It takes a few seconds for the testing to stop after ABORT is pressed.

After measurements are completed, the following screen is displayed.

System Measurements
Making System Measurements

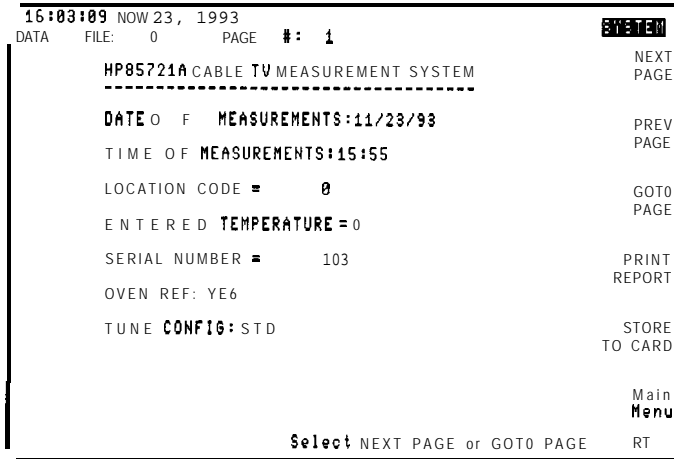

Figure 3-8. Tests Results Screen-Page 1

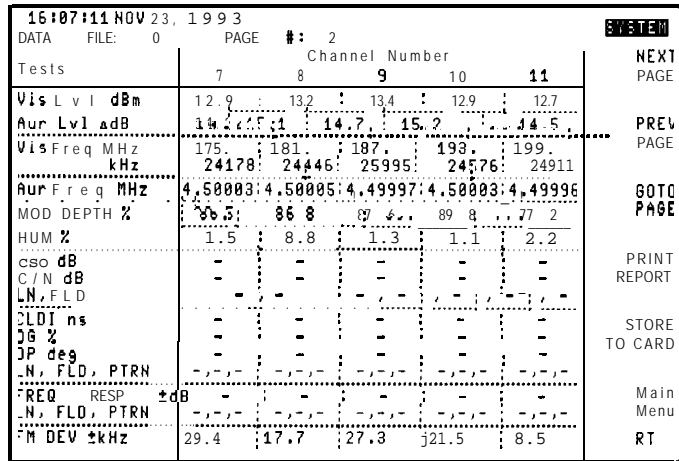

Figure 3-10. Tests Results Screen-Page 2

16:08:01 NOV 23, 1993		PAGE #: 3		SYSTEM
DATA FILE: 0	Channel Number			
Tests	12	13		
Vis Lvl dBm	12.8	11.9		NEXT PAGE
Aur Lvl dB	14.8	14.4		PREV PAGE
Vis Freq MHz	205.	211.		
kHz	224154	223850		
Aur Freq MHz	4.50001	4.50000		GOTO PAGE
MOD DEPTH %	87.8	88.8		
HUM %	1.5	2.3		
CSO dB	-	-		PRINT REPORT
C/N dB	-	-		
LN, FLD	-	-		STORE TO CARD
CLDI ns	-	-		
D6 %	-	-		Main Menu
DP deg	-	-		
LN, FLD, PTRN	-,-,-	-,-,-		RT
FREQ RESP dB	-	-		
LN, FLD, PTRN	-,-,-	-,-,-		
FM DEV kHz	19.8	25.1		

Figure 3-11. Tests Results Screen-Page 3

5. Press NEXT PAGE to view the next page or PREV PAGE to view the previous page.
6. Press GOTO PAGE to go to a specified page of test results.
7. Press PRINT REPORT to print the test results.
8. Press STORE TO CARD to store test data to a formatted RAM card.

Step 7. Access the spectrum analyzer mode

1. Press **MODE**, SPECTRUM ANALYZER

or

2. Press **PRESET**.

If you want to use the spectrum analyzer functions after using the cable TV measurement system, you need to access the spectrum analyzer mode. When the analyzer is in the spectrum analyzer mode, SYSTEM is no longer displayed in the upper right corner of the analyzer display.

To reaccess the cable TV measurement system, press **MODE**, CABLE TV ANALYZER.

Step 8. Access the TV receiver mode (optional)

1. Press **MODE**, TV RECEIVER
or
2. Press **PRESET** followed by **TV RECEIVER**
3. Press **CHANNEL SELECT**, enter the channel you want to view with the numeric keypad, then press **ENTER**. You can also select channels by using the large front-panel knob or front-panel arrow keys.
4. Press **PIX &SND ON OFF** to turn the picture and sound on.
5. Adjust the volume and intensity knobs for the desired volume level and picture intensity.
6. To exit TV picture and sound, press any of the following: **WINDOWS (ON)**, **AUX CTRL**, **MODE**, or any softkey.
7. Additionally, the TV picture and sound can be accessed from within the system measurements mode by pressing **WINDOWS (ON)**.
8. Channels can then be selected with the numeric keypad, then pressing **ENTER**. You can also use the knob or arrow keys for channel selection.
9. To exit TV picture and sound, press any of the following: **WINDOWS (ON)**, **AUX CTRL**, **MODE**, or any softkey.
10. To exit this mode press Prev Menu

NOTE

Option 107 is required to access the TV receiver mode. Connections must be made to TV IN as shown in Figure 3-4.

Making Timed System Measurements

This procedure describes how to make tests at a later time. Tests at a later time can also be repeated.

NOTE

Ensure that the analyzer's clock is set to the correct time and date.

1. If Timed Measure is not displayed, press **MODE**,
CABLE TV ANALYZER, SYSTEM MEAS
2. Press Timed Measure .
3. Press START TIME,
4. Enter the date that you want testing to begin. To enter the date, use the data keys to enter the date in a year, month, day format, then press **ENTER**. Or, press TODAY'S DATE if you want to use the current date as the start date.
5. Enter the time that you want testing to begin. To enter the time, use the data keys to enter the date in a 24-hour, hour, minute format, then press **ENTER**. Or, press TODAY'S TIMEDATE if you want to use the current date and time as the start date and time.
6. Press STOP TIME
7. Enter the date that you want testing to end. Enter the date (in year, month, day format) using the data keys, then press **ENTER**. Or, press TODAY'S DATE if you want to use the current date as the end date.
8. Enter the time (in 24-hour, hour, minute format) you want the testing to end using the data keys, then press **ENTER**.

9. Press **TIME INTERVAL** , then enter the time interval between measurements using the data keys, then press **(ENTER)**. Enter the time interval in an hour, minute, 24-hour format.
10. If you want the results to be printed, press **DUMP TO PRINTER** . For information about connecting the printer to the analyzer, see “Step 3. Install a printer” in Chapter 1.
11. If you want the results to be stored on the RAM card, press **DUMP TO RAM CARD** You will be prompted for a file number under which the first data file will be stored. Enter a starting file number, then press **(ENTER)**.
12. If you want to stop the testing, press **ABORT**. (It will take several seconds for the testing to stop.)

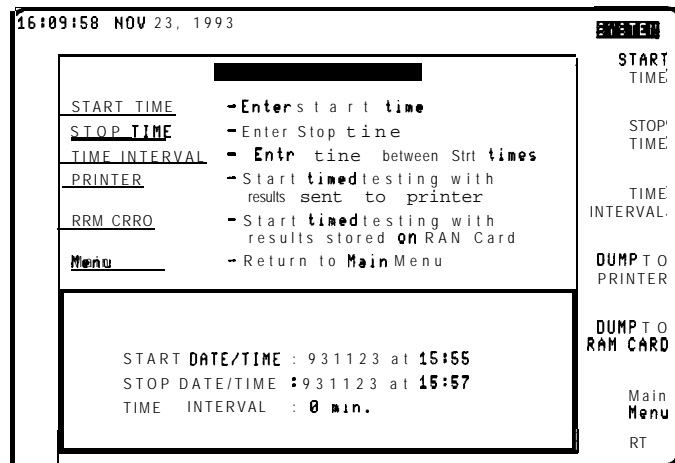

Figure 3-12. Timed System Measurements

Creating a Test Plan

A test plan consists of the channels that you want to measure and the tests you want to make on those channels. This section contains the procedure used to create a test plan. The procedure includes the following steps:

1. Select an individual channel.
2. Select a range of channels.
3. Save the current test plan in internal memory
4. Save the current test plan to a RAM card.

The Create Tstplan softkey is used to access the functions necessary to create a test plan. CLEAR TST PLAN clears the currently loaded test plan.

If You Make a Mistake

If you make a mistake when entering a number with the data keys, you can use the back space key to correct the mistake. The back space key (**BK SP**) is on the lower right corner of the spectrum analyzer's front panel, next to the **ENTER** key

It is very important to survey your system before creating a test plan. You must be familiar with the location of quiet lines, test signals available on a given channel, test signal location (line number), and appropriate field.

To facilitate this survey, use the chart provided in Chapter 9.

Use the channel measurements mode to survey each channel, then record the information in the chart.

Step 1. Select an individual channel

1. If ENTER BY CHANNEL is not displayed, press **MODE**,
CABLE TV ANALYZER , SYSTEM **MEAS** , More 1 of 2 ,
Create **TstPlan** .
2. Press ENTER BY CHANNEL
3. Use the data keys to enter the channel number, then press **ENTER**.

NOTE

Valid channel numbers are 0 through 999. Valid standard channels with Option 107 are 2 through 134
T (upstream) channels are supported when the test plan contains channels 7 through 13 and "T"
channels is underlined in the channel-tuning key in setup.

4. If the channel that you have entered is a scrambled channel, press YES
If the channel is not scrambled, press NO
5. Select the tests for the channel.
 - If you want to delete all of the tests for the channel, press
CLEAR TESTS
 - If you want to select all the tests, press ALL TESTS
 - If you want to specify which tests are to be performed, use the data
keys to enter the number of the test, then press **ENTER**. Repeat this
step for all of the test numbers that you want to select.
 - If you selected the carrier-to-noise and/or CSO test, enter the quiet line
number and odd, even, or both fields when prompted. Using both
fields where possible speeds up the test.

Creating a Test Plan

- If you selected a video test (differential gain, differential phase, and/or chroma/luma delay), enter the line number of the test signal, odd or even field, and the desired test signal type when prompted.
 - If you selected the in-channel frequency response test, enter the frequency response line number, odd, even, or both fields, and the desired test signal type when prompted.
6. After you have selected the test or tests, press DONE
 7. If you want to enter another channel, repeat steps 3 through 6. If you do not want to enter another channel, press Prev Menu.
 8. If you want to view selected channels, press VIEW CH SEL

You can enter channels into the test plan as individual channels or as a range of channels. This procedure describes how to enter channels individually into the test plan. The next procedure describes how to enter a range of channels into the test plan.

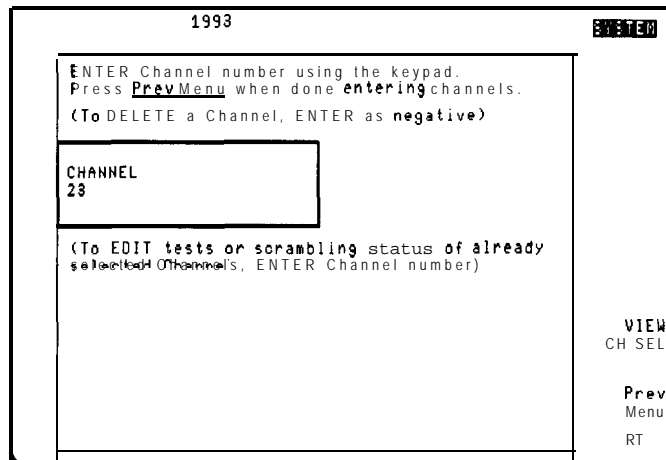

Figure 3-13. Enter by Channel

Step 2. Select a range of channels (optional)

1. If ENTER BY RANGE is not displayed, press **MODE**,
CABLE TV ANALYZER , SYSTEM MEAS , More 1 of 2 ,
Create TstPlan
2. Press ENTER BY RANGE.
3. Enter the number of the first channel in the range of channels you want to measure. Use the data keys to enter the first channel number, then press **ENTER**.
4. Enter the number of the last channel in the range of channels you want to measure. Use the data keys to enter the last channel number, then press **ENTER**.
5. After the channel range has been entered, you need to press YES if the range of channels is scrambled, or press NO if the range of channels is not scrambled.

NOTE

The scrambled or unscrambled channel status applies to the range of channels that you have just entered.

6. Select the tests for the range of channels.
 - If you want to delete all of the tests, press CLEAR TESTS
 - If you want to select all the tests, press ALL TESTS
 - If you want to specify which tests are to be performed, use the data keys to enter the number of the test, then press **ENTER**. Repeat this step for all of the test numbers that you want to select.

Creating a Test Plan

- If you selected the carrier-to-noise and/or CSO test, enter the quiet line number and odd, even, or both fields when prompted.
- If you selected the in-channel frequency response test, enter the frequency response line number, odd, even, or both fields, and the desired test signal type when prompted.
- If you selected a video test (differential gain, differential phase, and/or chroma luma delay), enter the line number of the test signal, odd or even field, and the desired test signal type when prompted.

NOTE

The same quiet line and test signal numbers selected here will be used for all selected channels when using **ENTER BY RANGE**.

7. After you have selected the test or tests, press **DONE**.

8. If you want to view the selected channels, press **VIEW CH SEL**.

You can enter channels into the test plan as individual channels or as a range of channels. This procedure described how to enter a range of channels into the test plan.

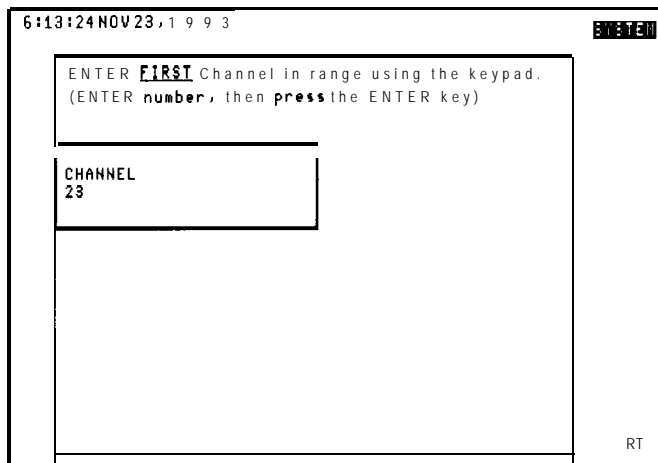

Figure 3-14. Enter by Range-First Channel Number

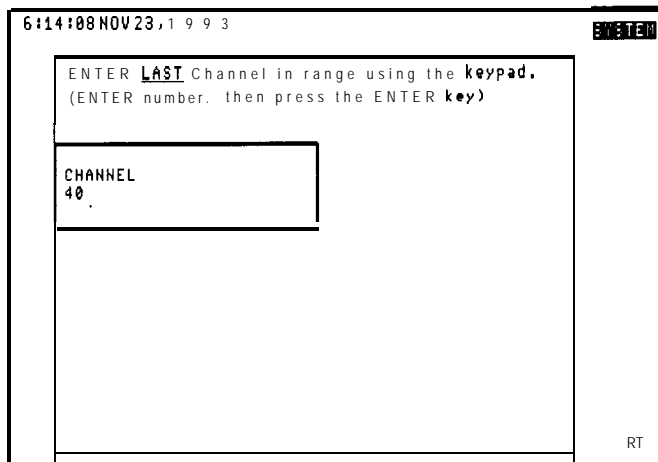

Figure 3-15. Enter by Range-last Channel Number

Step 3. Save the current test plan in internal memory

NOTE

Test plans 1 through 5 are saved in trace registers 6 through 10 in the analyzer. Do not save traces in trace registers 6 through 10 or your test plans will be overwritten.

1. If Save TstPlan is not displayed, press **(MODE)**, **CABLE TV ANALYZER** , **SYSTEM MEAS** , More 1 of 2, Create TstPlan
2. A title can be entered with each test plan. The title can be used to differentiate between test plans. The title is shown when cataloging analyzer memory. See “Cataloging Analyzer Memory” in this chapter.
 - a. If you want to create a title using the analyzer’s keys, press **(DISPLAY)**, then **CHANGE TITLE**, **YZ_#** SPC **CLEAR**, **CLEAR** to clear the current title.
 - b. Use the softkeys to create a new title. For example, press **ABCDEF** , **C** , **ABCDEF** , **A** , **STUVWX** , **T** , **STUVWX** , **V** to create the title “CATV.”
 - c. Press **(MODE)** **(MODE)** to return to the Create **TstPlan** menu.
 - d. If you want to create a title using an external keyboard, press **(ESC)**, **(ENTER)** on the external keyboard to clear the current title. Press **(ESC)**, then the keys to create the title, the press **(ENTER)**.

3. Press **Save TstPlan**.
4. Press **SAVE TO INT MEM**
5. Because there can be up to Eve different test plans saved in analyzer memory, you need to select a number under which to save the test plan. Press the softkey with the plan number under which you want the test plan saved. For example, press **PLAN 1** to save the test plan in plan number 1.
6. Press **DONE**.

You can save up to Eve different test plans in analyzer memory. The test plans are stored in memory even if the analyzer is unplugged from a line power source.

The channel numbers, tests, scrambling status, channel tuning configuration, quiet line number, frequency response line number, color test line number, test signal type, and Eeld information are stored for each test number of each channel with the test plan.

Saving a test plan overwrites any previously saved test plan for the same test plan number.

Step 4. Save the current test plan to a RAM card (optional)

1. If SAVE TO MEM CARD is not displayed, press (MODE),
CABLE TV ANALYZER, SYSTEM MEAS, More 1 of 2,
Create **TstPlan**, Save **TstPlan**.
2. Press SAVE TO MEM CARD.
3. Because there can be up to Eve different test plans saved in analyzer memory, you need to select a number under which to save the test plan. Press the softkey with the plan number under which you want the test plan saved. For example, press PLAN 1 to save the test plan in plan number 1.
4. Press DONE.

Editing the Current Test Plan

1. If Create **TstPlan** is not displayed, press **(MODE)**,
CABLE TV ANALYZER, SYSTEM **MEAS** , More **1** of **2**.
2. Press Create **TstPlan** to access the menu functions for creating a test plan.
3. Press **ENTER BY CHANNEL** .
4. If you want to delete a channel, enter the channel number as a negative number. (To enter a negative number, use the **(BK SP)** key to enter the minus sign, then use the data keys to enter the channel number.) Press **(ENTER)** after the channel number has been entered.
5. If you want to change the scrambling status for the channel, enter the channel number using the data keys. Press **(ENTER)**. You will be prompted for the scrambling status of the channel and the tests that you want performed on the channel. Press **DONE** after all of the desired tests have been selected.
6. If you want to edit the tests, enter the channel number using the data keys, then press **(ENTER)**. You will be prompted for the scrambling status of the channel and the tests that you want performed on the channel. If you want to delete a test, enter the test number as a negative number. (To enter a negative number, use the **(BK SP)** key to enter the minus sign, then use the data keys to enter the test number.) Press **(ENTER)** after the test number has been entered. Press **DONE** after all of the desired tests have been selected.
7. If you want to edit another channel, repeat steps 4 through 6. If you do not want to enter another channel, press **Prev Menu**.
8. Save the edited test plan as described in Steps 3 or 4 of the “Creating a Test Plan” procedure.

You can delete a channel, change the tests for a channel, or change the scrambling status of a channel with **ENTER BY CHANNEL**

Clearing the Current Test Plan

1. If Create **TstPlan** is not displayed, press **(MODE)**,
CABLE TV ANALYZER, SYSTEM MEAS, More 1 of 2.
2. Press Create **TstPlan**.
3. Press CLEAR TST PLAN YES.
4. Press Prev Menu to return to the main menu.

This procedure describes how you can clear the current test plan. The current test plan is the test plan that is displayed when you press VIEW CH SEL, and it is the test plan that is used when making a measurement.

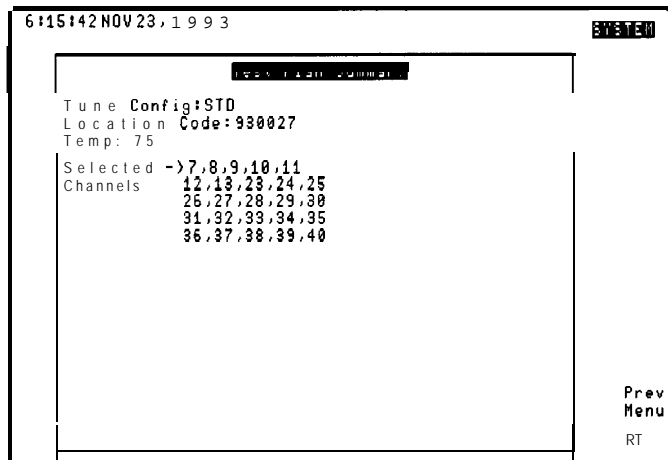

Figure 3-16. View Current Test Plan

Cataloging Analyzer Memory

1. Press **SAVE** or (**RECALL**).
2. Press INTERNAL CARD so that INTERNAL is underlined.
3. Press Catalog Internal , CATALOG REGISTER.
4. Turn the large knob on the analyzer's front panel to scroll down the catalog entries displayed on the analyzer screen. The test plans are saved in trace registers (TR) 6 through 10.
5. If SYSTEM is still displayed in the upper-right corner of the analyzer display, you can press **MODE** **MODE** to return to the current cable TV measurement system menu.

You may need to catalog analyzer memory if you are unsure of how many test plans have been saved in analyzer memory.

If a test plan has been saved in analyzer memory, the trace register's catalog entry shows the date that the test plan was saved. The date is displayed after the trace register (TR) number and TL : If the test plan was saved with a title, the title will be displayed also.

```
16:16:39 NO'J 23, 1993 SYSTEM
LOAD
FILE
ST/TR REG:
ST1 CF: 300 MHz SP: 8 Hz
ST2 CF: 900 MHz SP: 108.0 kHz
ST3 CF: 1.500GHz SP: 100.0 kHz
ST4 CF: 900 MHz SP: 1.808 GHz
ST5 CF: 900 MHz SP: 1.800 GHz
ST6 CF: 900 MHz SP: 1.800 GHz
ST7 CF: 900 MHz SP: 100.0 kHz
ST8 CF: 213 MHz SP: 6.088 MHz
TR0 TL: 21:20:27 AUG 31, 1993
TR1 TL: 21:20:27 AUG 31, 1993
TR2 TL: 15:31:22 NOV 23, 1993
TR3 TL: 21:20:27 AUG 31, 1993
TR4 TL: 21:20:28 AUG 31, 1993
TR5 TL: 21:20:28 AUG 31, 1993
TR6 TL: 16:05:04 NOV 16, 1993
TR7 TL: 19:45:34 NOV 03, 1993
TR8 TL: 01:37:13 SEP 01, 1993
TR9 TL: 21:20:28 AUG 31, 1993
Exit
Catalog
Previous
Menu
RT
```

Figure 3-17. Catalog Analyzer Internal Memory

Recalling a Test Plan from a RAM Card

1. If RECALL FRM CRD is not displayed, press **MODE**,
CABLE TV ANALYZER, Recall **TstPlan**.
2. Press RECALL FRM CRD .
3. Press the softkey with the plan number you want to recall. For example,
press PLAN 1 to recall the test plan in plan number 1.
4. Press DONE.

Recalling Test Data from the RAM Card

1. If you have not done so already, connect the printer to the analyzer as described in “Step 3. Install a printer,” located in Chapter 1.
2. If Recall Data is not displayed, press **(MODE), CABLE TV ANALYZER**,
More 1 of 2.
3. Press Recall Data.
4. Use the large knob on the analyzer’s front panel to select the file that you want. To select a file, turn the knob until the file that you want is highlighted.
5. Press DATA TO PRINTER to print the test data.
6. Press DATA TO SCREEN to display test data on the screen.

Cataloging a RAM Card

1. If CATALOG CARD is not displayed, press **MODE**, CABLE TV ANALYZER ,
SYSTEM MEAS , More 1 of 2
2. Press CATALOG CARD.

CATALOG CARD displays a catalog listing of all the files on a RAM or ROM card.

Formatting a RAM Card

1. Check that the switch on the RAM card to be formatted is set so the card is not write protected.
2. Insert the RAM card into the analyzer with the card's arrow matching the raised arrow on the bezel around the card-insertion slot.
3. Press **CONFIG**, MORE 1 of 3 , Card Config .
4. Press **FORMAT CARD** , **FORMAT CARD** This formats the RAM card.
5. If **SYSTEM** is still displayed in the upper-right corner of the analyzer display, you can press **MODE**, (MODE) to return to the current cable TV measurements menu.

Before you use the RAM card for the first time, you must format the RAM card. Once the RAM card has been formatted, the test plan and test data can be saved on it.

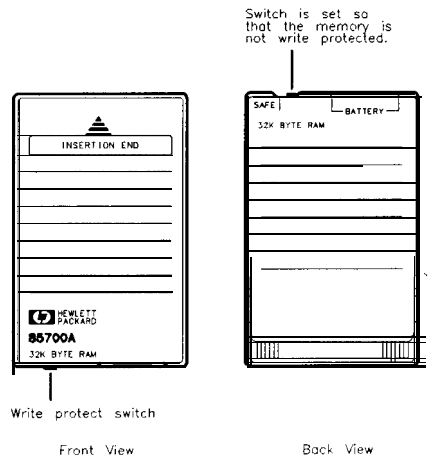

py219

Figure 3-18. A RAM Card

Deleting All the Files from a RAM Card

1. Ensure the write-protect switch is set so that the RAM card is not write protected.
2. Insert the RAM card in the card reader.
3. Press **CONFIG**, MORE 1 of 3 , Card Config
4. Press BLANK CARD, BLANK CARD.
5. If SYSTEM is still displayed in the upper-right corner of the analyzer display, you can press **MODE** **MODE** to return to the current cable TV measurements menu.

Deleting Individual Files from a RAM Card

1. Ensure the write-protect switch is set so that the RAM card is not write protected.
2. Insert the RAM card in the card reader.
3. Press **SAVE** or **RECALL**.
4. Press INTERNAL CARD so that CARD is underlined.
5. Press Catalog Card , CATALOG ALL
6. Turn the large knob on the analyzer's front panel until the file that you want to delete is highlighted.
7. Press DELETE FILE, DELETE FILE.
8. If SYSTEM is still displayed in the upper-right corner of the analyzer display, you can press **MODE** **MODE** to return to the current cable TV measurements menu.

You may want to delete one or more files from the RAM card to make room for new files to be stored on the RAM card.

System Measurements

Deleting Individual Files from a RAM Card



————— If You Have a Problem

If You Have a Problem

The purpose of this chapter is to help you if you have a problem operating in cable TV analyzer mode. If the problem is related to the spectrum analyzer mode of operation, consult the documentation for the analyzer.

This chapter is divided into the following sections:

- Problems that are indicated by error messages that appear on the analyzer display.
- Other types of problems (problems that are not indicated by error messages).
- How to contact Hewlett-Packard.

Error Messages

NOTE

If you press a **softkey** or a front-panel key while an error message is displayed, the analyzer may “remember” each key press. Therefore, we recommend that you do not press any keys while the error message is displayed on the analyzer display

The error messages are listed alphabetically by the first word in the message.

ALREADY ENTERED

This message indicates that the channel number or test number has already been selected.

To solve this problem:

- If you want to delete the channel or edit the tests for the channel, use ENTER BY CHANNEL.
- If you want to enter a range of channel numbers, select another channel number that has not already been entered.

CAUTION - Recalled Test Plan Corrupted Selected Test Plan Cleared

This message can be caused by the following:

- A test plan was not saved in the test plan number that you are trying to recall.
 - If you are not sure of the test plan number, catalog the trace registers of analyzer memory as described in “Cataloging Analyzer Memory” in Chapter 3. The catalog listing will show if a test plan has been saved in the trace register.
- A trace has been stored in the trace register for the test plan, overwriting the test plan. (Remember that the test plans are stored in trace registers 6 through 10.)
 - If a trace has been saved in the trace register for the test plan, you will need to reenter the test plan.

CAUTION - STOP TIME ALREADY PASSED

This message indicates that testing did not begin before the stop time occurred.

To solve this problem:

- Reenter the start date and time and the stop date and time.

CAUTION - STOP TIME LESS THAN START TIME. SET STOP TIME AND TRY AGAIN

This message indicates that the ending date or time occurs before the starting date and time.

To solve this problem:

- Reenter the stop date and time. Remember that the time is entered in a 24-hour, hour, minute format.

CHECK CARD IN SLOT (SAVE OFF?)

This message indicates that the analyzer cannot write to the RAM card because the RAM card has not been inserted into the memory card reader or the write-protect switch on the RAM card is set to the write-protect position.

To solve this problem:

- Insert the RAM card in the analyzer's memory card reader.
- Move the write-protect switch away from the "SAFE" position. See "Formatting a RAM Card" in Chapter 3 for more information.

ILLEGAL COMMAND

If you see this message while loading the HP 85721A personality into analyzer memory, it indicates that the analyzer's firmware must be updated before the personality can be used.

- Check the Ermware date for your analyzer:
 - Turn on the analyzer. The Ermware date is displayed on the analyzer's display when the analyzer is first turned on. The date is displayed in a year, month, day, format. For example, if rev 93.09.23 is displayed, the release date of the Ermware was September 23, 1993.

To solve this problem:

- If the release date for the analyzer's firmware was prior to September 23, 1993, the firmware must be updated to use the HP 85721A personality. Contact your HP sales office for more information about updating analyzer Ermware.

INVALID SYMTAB ENTRY: SYMTAB OVERFLOW

This error message indicates that there was not enough available analyzer memory.

To solve this problem, you must delete the other programs in the analyzer memory as follows:

1. Press **PRESET**.
2. Press **CONFIG**, MORE 1 of 3 , DISPOSE USER MEM, ERASE DLP MEM, ERASE DLP MEM , **PRESET**.
3. Reload the HP 85721A personality using the procedure "Step 1. Load the HP 85721A personality into analyzer memory" in Chapter 1.

INVALID FILE NO ROOM

The message INVALID FILE NO ROOM indicates that there is not enough space available on the RAM card to save the file.

To solve this problem, you can delete one or all unwanted files from the RAM card.

- To delete files individually from the RAM card, follow the procedure in “Deleting Individual Files from a RAM Card” in Chapter 3.
- To delete all the files from the RAM card, follow the procedure in “Deleting All the Files from a RAM Card” in Chapter 3.

MUST BE > FIRST

This message indicates that the last channel number entered for a range of channel numbers is less than the first channel number.

To solve this problem:

- Enter a channel number for the last channel number that is greater than the first channel number.

NO CARD FOUND

This message indicates that a memory card has not been inserted into the analyzer's memory card reader.

To solve this problem, insert the appropriate RAM or ROM card into the memory card reader.

- If you want to load the HP 85721A personality, insert the HP 85721A personality's ROM card into the memory card reader.
- If you want to store or recall data, insert a RAM card into the memory card reader.

NO TEST PLAN SELECTED

This message indicates that there is not a current test plan to test

To solve this problem, you need to create a test plan or recall a saved test plan.

- For information about creating a test plan, see "Creating a Test Plan" in Chapter 3.
- For information about recalling a previously saved test plan, see "Recalling a Test Plan from a RAM Card" in Chapter 3.

OUT OF RANGE

The message OUT OF RANGE indicates that the value that you entered was not within the range for the function.

To solve this problem:

- Enter values within the range for the function. See Chapter 3 for more information about using the cable TV analyzer functions. See Table 4-1 for information about the range of values for the cable TV analyzer functions.

Table 4-1. Ranges for the Cable TV System Monitor Functions

Function	Range
ENTER LOCATION	Up to seven digits long
ENTER TEMP	-999 to +999
Test number	1 to 9 [or -1 to -9 for deleting a test number]
Channel number	1 to 158 (or -1 to -158 for deleting a channel number)
File number	1 to 12

PLEASE SELECT A CHANNEL

This message indicates that a channel was not selected before executing a measurement.

To solve this problem:

- Press CHANNEL SELECT in the CHANNEL MEAS Main 1 of 3 menu, enter a channel number using the data keys, then press **ENTER**.

PRINTER IS NOT CONNECTED, NOT TURNED ON, OR A CONTROLLER CONFLICT EXISTS

This message indicates that the analyzer cannot “talk” to the printer.

NOTE

Plotters are not supported

To solve this problem:

1. Make sure that the printer is turned on
2. Make sure that the analyzer is connected to the printer correctly. See “Step 4. Install a printer” in Chapter 1 for more information.
3. *For **Option 021 only***: If you have both a computer and a printer connected to the analyzer, you need do one of the following:
 - Disconnect the computer from the analyzer.
 - Send the BASIC commands ABORT 7, then send LOCAL 7 to the analyzer before trying to print.

RAM CARD REQUIRED

This message indicates that you have instructed the HP 85721A personality to write information to a ROM card. A ROM card can only be read; a RAM card can both be read and written to.

To solve this problem:

- Remove the ROM card from the analyzer's memory card reader and insert a formatted RAM card. If the RAM card needs to be formatted, see "Formatting a RAM Card" in Chapter 3.

RAM CARD IS NOT FORMATTED, FORMAT RAM CARD AND TRY AGAIN

This message indicates that the RAM card is unformatted.

To solve this problem:

- Format the RAM card as described in "Formatting a RAM Card" in Chapter 3.

VIDEO SYNC NOT RECOGNIZED

This message indicates that a TV line with horizontal sync could not be found.

To solve this problem:

- Connect coupler as shown in Figure 3-4 in Chapter 3.
- Turn off channel scrambling.

Other Problems

This section lists problems that are not indicated by an error message.

If a test fails in **SYSTEM MEAS** mode

If a test fails in the **SYSTEM MEAS** mode, confirm the failure using **CHANNEL MEAS** mode. This may involve disabling carriers or modulation according to FCC rules. Relative measurements showing cable TV equipment contributions may also be helpful in meeting FCC requirements.

If files are missing from a RAM card

A RAM card is able to store files because the RAM card's memory is refreshed by a battery. The battery needs to be replaced periodically or the RAM card can "forget" the files.

- Check that the battery in a 128 kilobyte RAM card has been replaced within the last year. Check that the battery in a 32 kilobyte RAM card has been replaced within the 2 last years. (See the analyzer documentation for information about the replacement date of the RAM card's battery.) If the battery has not been replaced within the recommended time period, change the battery.

To change the battery:

- See the analyzer documentation for information about replacing the battery.

If a “-” appears in the data fields

A “-” appears in the data field if the test was not selected.

- If the test data for a channel is missing, check that the test has been selected. To check that the test has been selected:
 1. If necessary, recall the test plan
 2. Press ENTER **BY CHANNEL** , enter the channel number, and select the scrambling status. The tests selected for the channel will be displayed
 3. If necessary, enter the test number for the test that you want to select and repeat the testing.
- If the test data for a channel is missing and the test had been selected, check that the test could be performed on the channel.
 - For example, if the test measures both the visual and aural carriers, check that there is an aural carrier present.
- If the system composite second order (CSO) and composite triple beat (CTB) test data is missing, ensure that YES was selected when the CSO and CTB testing prompt appeared. (The selection for CSO and CTB testing is not saved with the test plan.)

To check and select CSO and CTB testing:

1. Press Measure Now YES CSO and CTB testing will be performed on the channel specified by the SYS BTS TST CHNL softkey in the Setup menu.
2. If NO is selected after pressing Measure Now , CSO and CTB testing will not be performed.

If the test results are not what you expected

If the test results are not what you expected, it could be because of one of the following:

CAUTION

Do not exceed the specified power input limit for the analyzer.

- I The input signal was not connected.
 - Ensure that the signal is present at the analyzer input.
 - Ensure that the coupler connections and rear-panel connections are made. See Chapter 2 for more information.
 - Ensure proper test signals, line location and field number were specified for the Option 107 required tests.
- The input signal is too low to be measured.
 - If the input signal is too low, use a preamplifier to boost the input signal (ensure that the voltage and power of the input signal does not exceed the specified input limits for the analyzer). See “Cable TV Measurement Specifications and Characteristics” in Chapter 9 for more information about the minimum carrier level needed.
- The wrong tune configuration was selected.
 - Ensure that the correct tune configuration has been selected.
- The external pad function was selected, but an external pad was not used
 - If you are not using an external pad, ensure that EXT PAD YES NO softkey label has NO underlined. See “Step 1. Configure the test system” in Chapter 3 for more information.

If the wrong date or time is displayed

The analyzer has a real-time clock that is powered by an internal battery.

If the real-time clock is set to the wrong time or date, use the following procedure to reset the time and date:

1. Press **CONFIG**, **TIMEDATE**
2. If the time and date are not displayed in the upper-left corner of the analyzer screen, press **TIMEDATE ON OFF** so that ON is underlined.
3. To reset the time, press **SET TIME** , enter the time (in 24-hour format) in the hour, minute, second format using the data keys, then press **ENTER**. For example, entering 133010 corresponds 1:30:10 PM.
4. To reset the date, press **SET DATE** , enter the date in the year, month, day format, then press **ENTER**. For example, entering 910305 corresponds to March 5, 1991.

How to Contact Hewlett-Packard

In the unlikely event something goes wrong with your analyzer, refer to the documentation for the analyzer about returning it for service. If you need to contact Hewlett-Packard for a problem with the HP 85721A personality, you can call your nearest Hewlett-Packard Sales and Service office listed in the following table.

Hewlett-Packard Sales and Service Offices

US FIELD OPERATIONS			
Headquarters Hewlett-Packard Co. 19320 Pruneridge Ave. Cupertino, CA 95014 (800) 752-0900	California, Northern Hewlett-Packard Co. 301 E. Evelyn Mountain View, CA 94041 14151 694-2000	California, Southern Hewlett-Packard Co. 1421 South Manhattan Ave. Fullerton, CA 92631 17141 999-6700	Colorado Hewlett-Packard Co. 24 Inverness Place, East Englewood, CO 80112 (303) 649-5512
Atlanta Annex Hewlett-Packard Co. 2124 Barrett Park Drive Kennesaw, GA 30144 14041 648-0000	Illinois Hewlett-Packard Co. 5201 Tollview Drive Rolling Meadows, IL 60008 (708) 255-9800	New Jersey Hewlett-Packard Co. 150 Green Pond Rd. Rockaway, NJ 07866 (201) 586-5400	Texas Hewlett-Packard Co. 930 E. Campbell Rd. Richardson, TX 75081 12141 231-6101
EUROPEAN FIELD OPERATIONS			
Headquarters Hewlett-Packard S.A. 150, Route du Nant-d'Avril 1217 Meyrin 2/Geneva Switzerland (41 221 780.8111	France Hewlett-Packard France Avenue Du Canada Zone D'Activite De Courtaboef F-91947 Les Ulis Cedex France 133 1) 69 82 60 60	Germany Hewlett-Packard GmbH Hewlett-Packard Strasse 61352 Bad Homburg v.d.H Germany {49 61721 16-0	Great Britain Hewlett-Packard Ltd. Eskdale Road, Winnersh Triangle Wokingham, Berkshire RG41 5DZ England 144 7341 696622
INTERCON FIELD OPERATIONS			
Headquarters Hewlett-Packard Company 3495 Deer Creek Road Palo Alto, California, USA 94304-1316 (415) 857-5027	Australia Hewlett-Packard Australia Ltd. 31-41 Joseph Street Blackburn, Victoria 3130 161 31 895-2895	Canada Hewlett-Packard (Canada) Ltd. 17500 South Service Road Trans- Canada Highway Kirkland, Quebec H9J 2X8 Canada 15141 697-4232	China China Hewlett-Packard Company 38 Bei San Huan XI Road Shuang Yu Shu Hai Dian District Beijing, China 186 6 1) 256-6888
Japan Hewlett-Packard Japan, Ltd. 1-27-15 Yabe, Sagamihara Kanagawa 229, Japan 181 4271 59-1311	Singapore Hewlett-Packard Singapore (Pte.) Ltd. 150 Beach Road #29-00 Gateway West Singapore 0718 1651 291-9088	Taiwan Hewlett-Packard Taiwan 8th Floor, H-P Building 337 Fu Hsing North Road Taipei, Taiwan 1886 21 712-0404	

If You Have a Problem

How to Contact Hewlett-Packard



Channel Measurements
Menu Map and Softkey
Descriptions

Channel Measurements Menu Map and Softkey Descriptions

What You'll Find in This Chapter

This chapter contains the menu map and descriptions of the softkey functions used in channel measurements mode. This chapter contains the following sections:

- channel measurements menu map
- channel measurements softkey descriptions

Channel Measurements Menu Map

The following menu map shows all channel measurement mode softkeys and how they are accessed.

.

Channel Measurements Menu Map

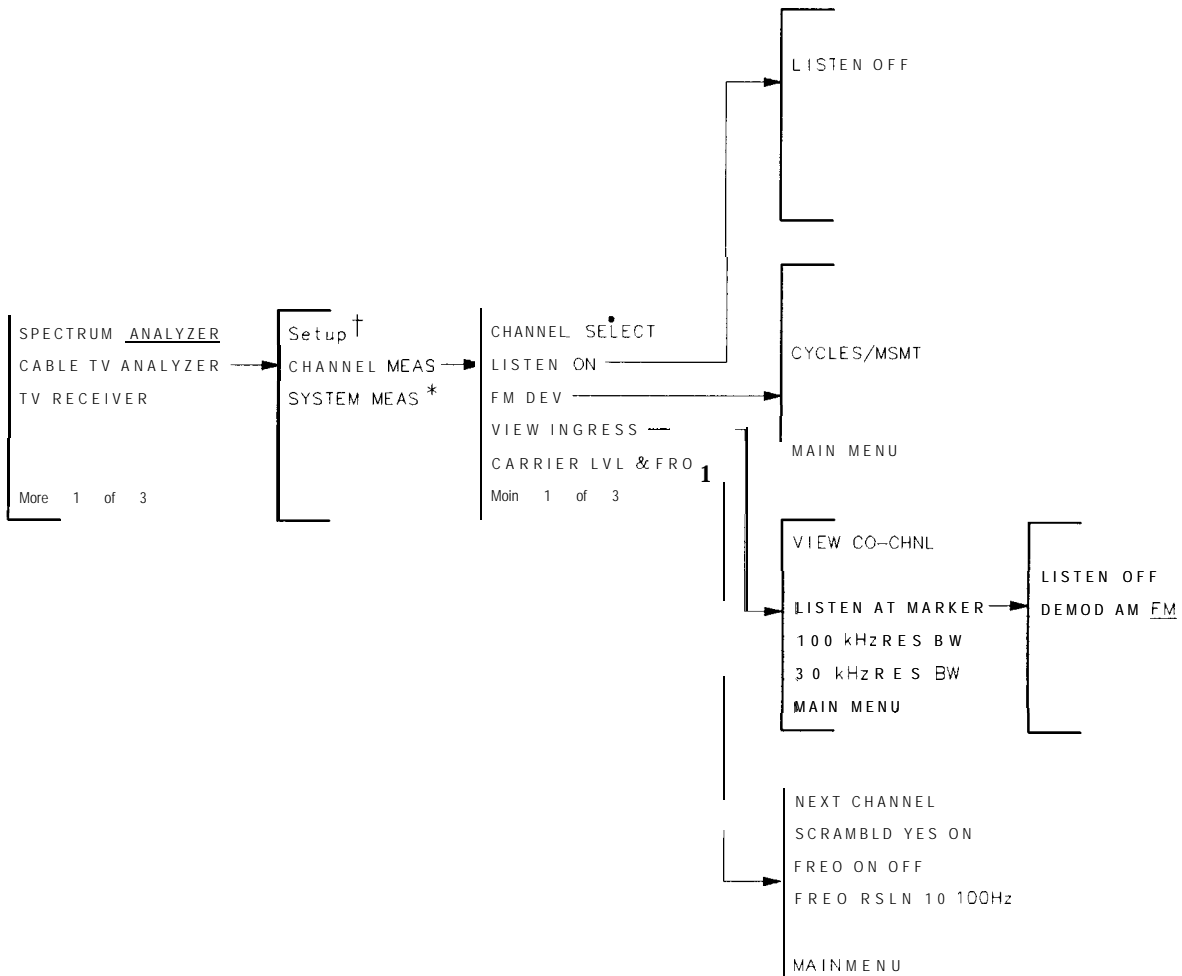

pf 79a

Figure 5-1. Channel Measurements Main Menu 1 of 3

* The **SYSTEM MEAS** softkey menus are found in Chapter 6.

† The **Setup** softkey menu is found in Chapter 7.

Channel Measurements Menu Map

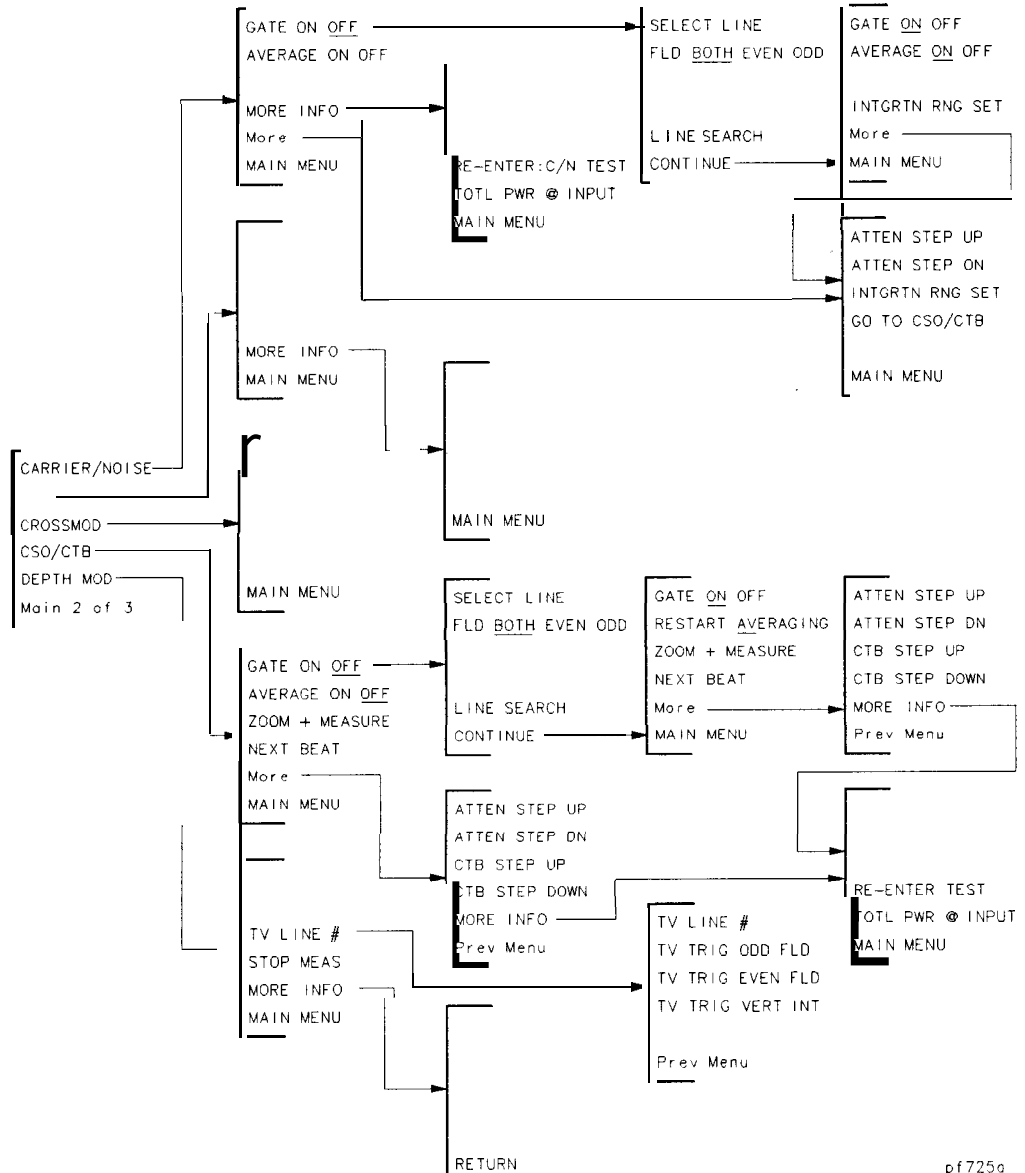
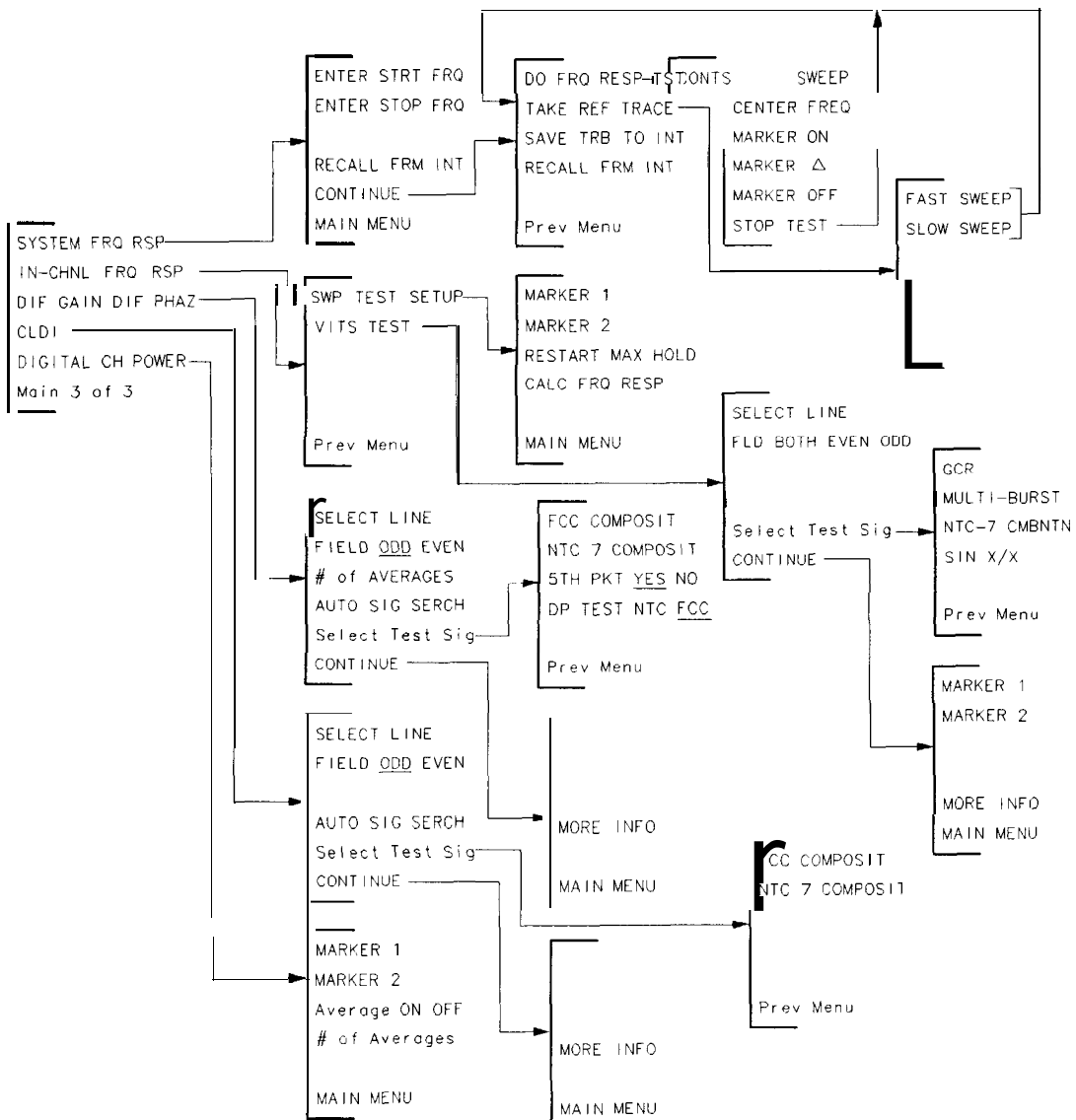

Figure 5-2. Channel Measurements Main Menu 2 of 3

pf725a

Channel Measurements Menu Map



pf726b

Figure 5-3. Channel Measurements Main Menu 3 of 3

DISPLAY

HOLD
DSP LINE ON/OFF
Change Title
Limit Lines
ANALOG+ ON/OFF
MORE 1 OF 2

pf719a

Figure 5-4. **DISPLAY** Menu

Channel Measurements Softkey Function Descriptions

This section contains the descriptions of the channel measurements softkey functions. The functions are listed alphabetically according to the softkey labels.

CHANNEL SELECT Description

Channel select is a function used in conjunction with measurements. It sets up the analyzer state for cable TV tests, lets you select a specific channel number, and centers the specific channel on the analyzer screen.

The channel is selected based on one of the Eve channel formats available in the Setup menu as described in Chapter 2: STD, AIR, HRC, IRC, or T.

The channel is displayed on screen in a 6 MHz span to show both the visual and aural carriers. The visual carrier is positioned just below the reference level.

As an alternative to selecting T in Setup , upstream (T) channels can be selected by entering negative channel numbers from any of the formats: STD, AIR, HRC, or IRC. For example, to select channel 7, enter -7.

FM broadcast station frequencies can be tuned by selecting channels 201 through 300. These channel designations are defined in the Code *of Federal Regulations*, Title 47, part 73.201.

Valid channels for gated (non-interfering) and color measurements are 2 through 134 standard tuning.

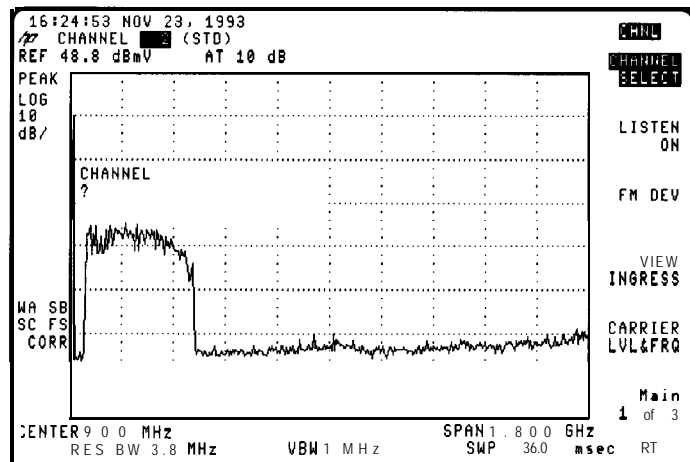

Figure 5-5. Select Channel

Procedure

1. To select a channel after the analyzer is preset or powered on, press the following analyzer keys:

MODE

CABLE TV ANALYZER

CHANNELMEAS

Enter the channel number, then press **ENTER** (lower right-hand hardkey). See Figure 5-5.

2. Up and down arrow keys (**↑**) and (**↓**) select the next higher or lower channel number, respectively.
3. The current channel number appears next to the channel format at the top of the screen in the title line. See Figure 5-6.

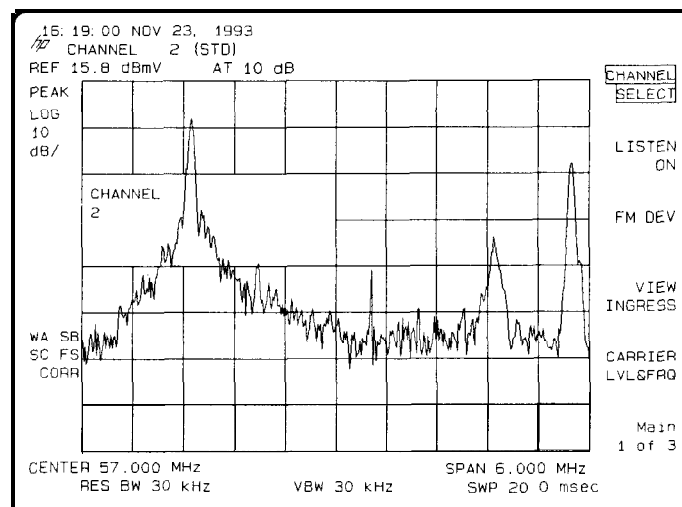

Figure 5-6. Channel Selected

Hints

1. The visual carrier of a channel must be "on" before the **CHANNEL SELECT** function can correctly center the channel.
2. Do not use the data knob for selecting channels.

DL DELTA ON OFF Description

The display line delta function displays the change, in percent, between a reference display line and the display line activated by pressing DL DELTA ON OFF. The percentage is displayed in the active function block.

Procedure

1. Set up the desired measurement.
2. Press **DISPLAY**, then DSP LINE ON OFF to activate the display line to be used as the reference.
3. Use the knob to position the display line.
4. Press More 1 of 2 , then DL DELTA ON OFF to activate the display line delta function.
5. Position the display line delta using the knob.
6. Read the percent change in the active function block.

Figure 5-7 shows the reference display line at the top of the signal and the display line delta at the bottom of the signal. The measurement shown was performed in Analog + display mode.

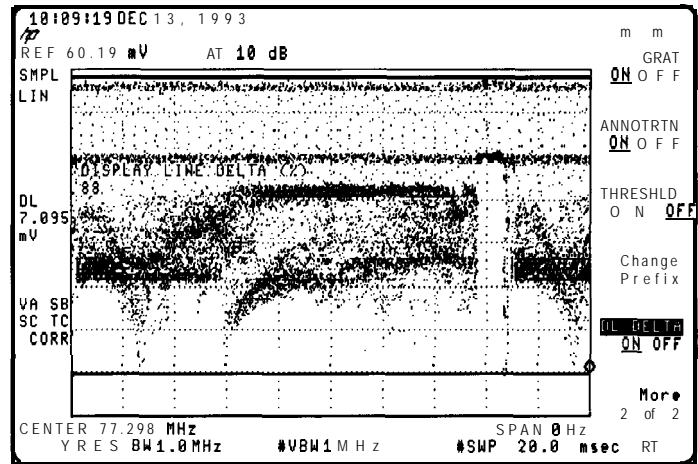

Figure 5-7. Display Line Delta

To increase the ability to view the DISPLAY LINE DELTA (%) value when it is obscured by a video signal (as in Figure 5-7), momentarily blank the active trace. For example, press Trace and then Blank A to view the value. Then press Clear Write A to reactivate the trace.



When using the delta display line function, if the active function control is transferred to some other function (for example, Amplitude) or turned off with Hold, the display line and delta display line must be set up again to reactivate the delta display line control.

Press **MODE** twice to return to the cable TV analyzer menu.

DO FRQ RESP TST Description

The frequency response measurement compares a spectrum stored at a reference point to a spectrum at any other point in the system where you want to evaluate the frequency response. The signal level and amplitude slope should be approximately the same as the reference trace.

Procedure

1. Take a reference trace, using TAKE REF TRACE or recall a trace from internal memory by using RECALL **FRM** INT Refer to the TAKE REF TRACE or RECALL FRM INT descriptions for more information about these functions.
2. After the reference trace appears on screen, press CONTINUE , then press DO FRQ RESP TST .
3. To align the frequency of the measurement trace with that of the reference trace, press CENTER FREQ , and use the  (step up) and  (step down) keys (do not use the data knob) to minimize amplitude ripple that may occur over the entire trace (small variations spaced by 6 MHz). Best results occur when the keys are pressed when the sweep is in the last division to the right. This adjustment is not necessary unless the ripple is annoying or your measurement must be very precise. At this point, you can use the marker functions to evaluate the data while the measurement is in progress. See Figure 5-8.

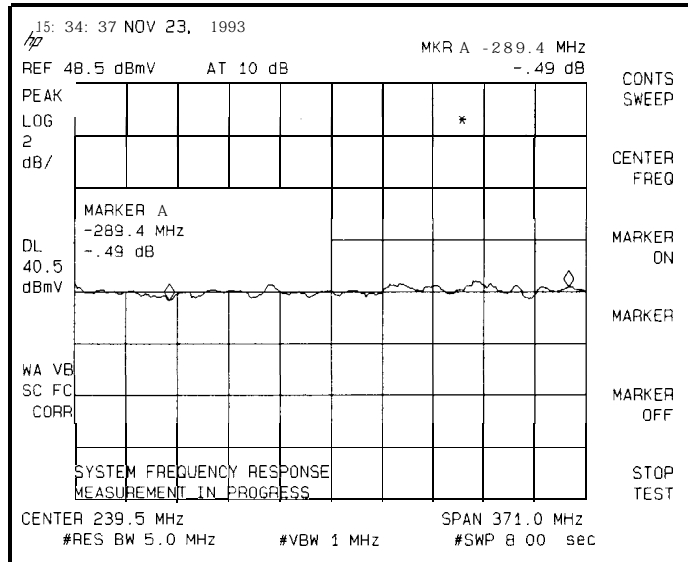

Figure 5-8. System Frequency Response

4. Pressing MARKER ON or MARKER DELTA assists the operator to End the peak-to-valley values using the marker. For ease of use, it is recommended to press **SGL SWP** hardkey before using these keys.
5. Pressing CONTS SWEEP restarts the sweep after having pressed the **SGL SWP** hardkey.
6. Pressing MARKER OFF turns the marker off.
7. To stop the test, press STOP TEST . This will stop the measurement and display the frequency response trace.
8. The results can now be stored to internal memory, memory card, or printed.

Notes

1. Do not press **DO FRQ RESP TST** without first recalling the reference to trace B. Using **RECALL FRM INT** automatically puts the trace into trace B.
2. Always press **STOP TEST** to exit the **DO FRQ RESP TST** function, otherwise the display will be left in 2 dB per division and the traces will likely be off the bottom of the screen.

GATE ON OFF Description

The gating function allows you to make carrier-to-noise and composite second order (CSO) distortion measurements without turning off modulation (Option 107 required).

The following procedure assumes that the GATING YES NO function in the Setup menu is set to NO. For more information about GATING YES NO , refer to “Step 1. Configure the test system” in Chapter 2.

Procedure

1. Select the required channel using the CHANNEL SELECT softkey. The analyzer automatically tunes to the selected channel.
2. After selecting the desired measurement, press GATE ON OFF to underline ON.
3. The analyzer automatically searches for a quiet line.

If the analyzer finds a quiet line, and if PAUSE YES NO in the Setup menu is set to NO, the measurement is executed. If the analyzer finds a quiet line, and if PAUSE YES NO in the Setup menu is set to YES, you must then press CONTINUE to execute the measurement.

4. If a quiet line cannot be found automatically, perform the following steps:
 - a. Press LINE SEARCH to perform an auto search, or press SELECT LINE , enter a line number using the data keys, then press **ENTER**.
 - b. Press FLD BOTH EVEN ODD if you want to change the Eeld.
 - c. Press CONTINUE to complete the measurement and display the test result on the screen.

5. Press the AVERAGE ON OFF softkey to perform a trace averaging function to smooth the trace.
6. In the carrier-to-noise measurement, press INTGRTN RNG SET to position the two markers within the desired measurement range.

Rather than using a single measurement point, the INTGRTN RNG SET softkey allows you to specify a range over which the measurement will be made. This accounts for the non-flatness of the noise floor.

LISTEN ON OFF Description

The listen on function is available in analyzers with demodulation capability (Option 102). The listen-on function demodulates the aural carrier so that it is audible through the built-in speaker.

Procedure

1. Select a channel, then press LISTEN ON .
2. Adjust volume with the front-panel volume knob.
3. Press LISTEN OFF to exit the function.

RECALL FRM INT Description

The recall from internal memory function recalls a trace into trace B for use as a reference trace or to recall a system frequency response trace.

This function simplifies recalling a trace from the analyzers internal memory. A trace can also be recalled from a memory card using procedures provided in the analyzer user's guide.

Procedure

1. To recall a trace into trace B, press RECALL FRM INT
2. After the message REGISTER # appears, enter the trace number the trace was stored under in SAVE TRB TO INT , then press **ENTER**.

The trace is recalled to trace B in view mode. It is complete when the message MAX REG # = 52 is added to the display as shown in Figure 5-9.

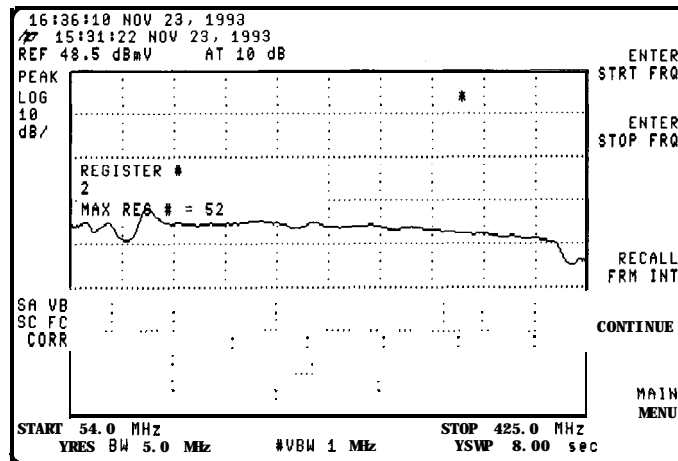

Figure 5-9. Trace B, Recalled

SAVE TRB TO INT Description

The save trace B to internal memory function stores trace B in internal memory.

This function simplifies saving either a reference trace or a test result to internal memory. This trace can also be saved to a memory card using procedures provided in the analyzer user's guide.

Procedure

1. After setting up to display the desired trace, press SAVE TRB TO INT
2. The message (ENTER 0-5 or 11 'THRU MAX REG #') appears. Enter a trace register number between 0 and the MAX REG #, then press **ENTER**.

Note that registers 6 through 10 are used by the HP 85721A personality. Therefore, it is recommended not to use these registers to save the reference trace.

3. Trace B is saved internally when the message TRACE B SAVED appears as shown in Figure 5-10.

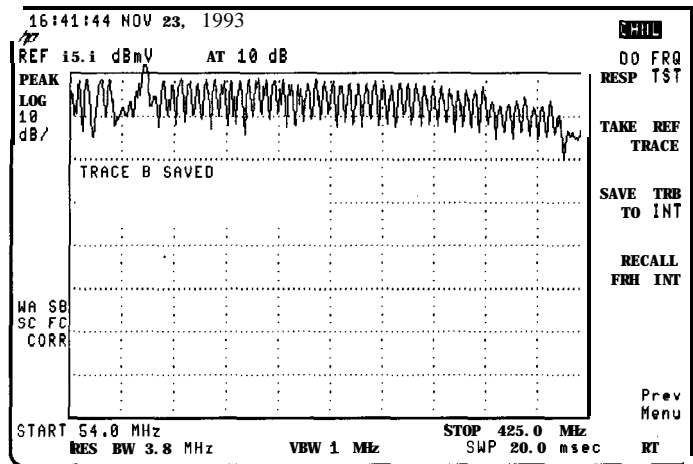

Figure 5-10. Trace B, Saved

NOTE

Another method of saving traces, internally or to a memory card, utilizes the functions under the **SAVE** key. Refer to the analyzer user's guide for a description.

Hint

When using this function to save reference traces, be sure to record the trace register that each reference trace was saved under. This precaution helps prevent restoring over useful reference traces and recalling the wrong register when using **DO FRQ RESP TST**

TAKE REF TRACE Description

Procedure

A reference trace measurement can be made at any point in the system that you want to use as the “reference.” For example, typical reference spectrums can be set up at the output of the headend or AML hub. Thirty-two or more reference traces can be stored.

1. Press the following analyzer keys:

Main 1 of 3 Main 2 of 3

SYSTEM **FRQ** RSP

2. Set the start and stop frequencies of the analyzer to include all channels being tested in the system.

- Press ENTER **STRT FRQ** , then enter the lowest channel frequency.
- Press ENTER **STOP FRQ** , then enter the highest channel frequency.

For your convenience when repeating this setup, save this analyzer state for later recall.

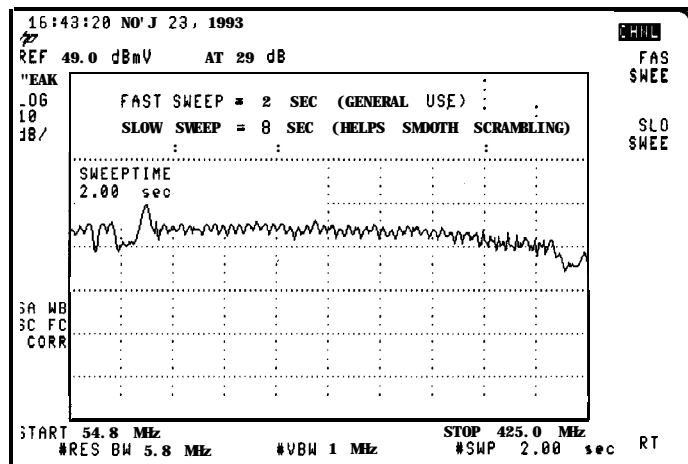

Figure 5-11. Fast and Slow Sweep

3. Sweep time is now the active function, if desired, adjust the sweep time before continuing the frequency response setup. If sweep time is not changed, the analyzer uses the default values.

Continue the frequency response setup by selecting FAST SWEEP or SLOW SWEEP . See Figure 5-11.

- If FAST SWEEP is pressed, the analyzer sweeps at the selected sweep time, or at the 2-second default value.
- If SLOW SWEEP is pressed, the analyzer sweeps at the 8-second default value.

During this setup step, the analyzer converts the reference spectrum into a reference trace, which connects the carrier peaks into a continuous line. When the setup is finished, the conditioned reference spectrum appears, as shown in Figure 5-12, along with the message SETUP FINISHED SAVE THIS TRACE.

Hints

A less accurate, but more real-time, response can be obtained by entering a faster sweep time such as 0.1 seconds. This response is more variable for scrambled channels, but still is useful for a quick look. Experiment to find your own optimum setup.

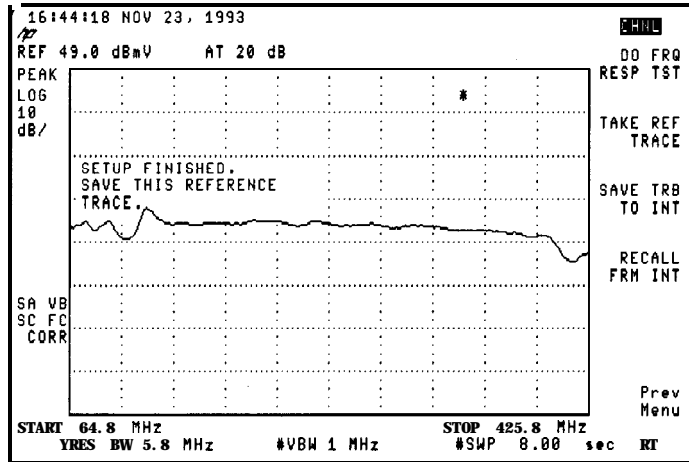

Figure 5-12. Conditioned Reference Spectrum

4. Press **SAVE TRB TO INT** , enter a trace register number, then press **ENTER** to store the reference spectrum and analyzer state in nonvolatile memory. See the **SAVE TRB TO INT** function for more information about saving trace B. Wait until the message **TRACE B SAVED** appears before proceeding. See Figure 5-13.
5. With a reference trace displayed on the analyzer press **DO FRQ RESP TST** to begin the actual comparison test between the reference and the signals under test. Refer to the section entitled “**DO FRQ RESP TST**” for more information.

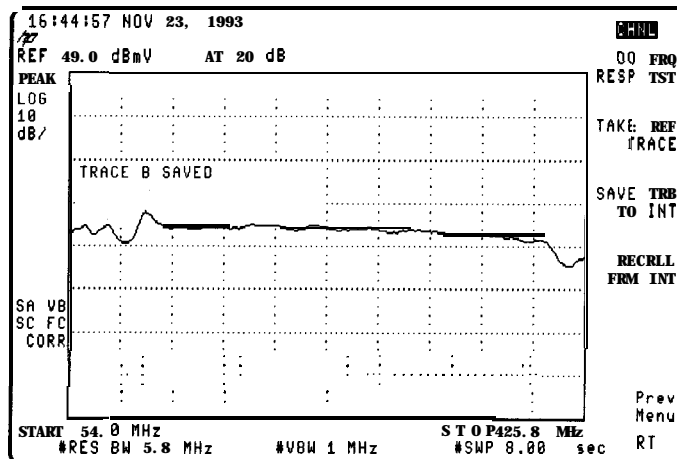

Figure 5-13. Trace B Saved to Internal Memory

Hints

1. **FAST SWEEP** is used for systems that do not have scrambled channels. However, the fast sweep is useful in making rough measurements and adjustments on systems with scrambled channels. More accurate results can be obtained in a following test with the slow sweep.
2. **SLOW SWEEP** allows the analyzer to measure the vertical sync pulse level when the horizontal sync pulse has been suppressed. An H-second sweep normally is optimum for this measurement, but for analyzer spans greater than 300 MHz, a slower sweep time may be necessary to reduce trace fluctuations caused by the scrambling.

VIEW CO-CHNL Description

This function allows the user to measure the relative power of any co-channel signal that is present.

Procedure

Observe the co-channel carrier in 10 kHz increments on either side of the main carrier by pressing the following analyzer keys:

VIEW INGRESS

VIEW CO-CHNL

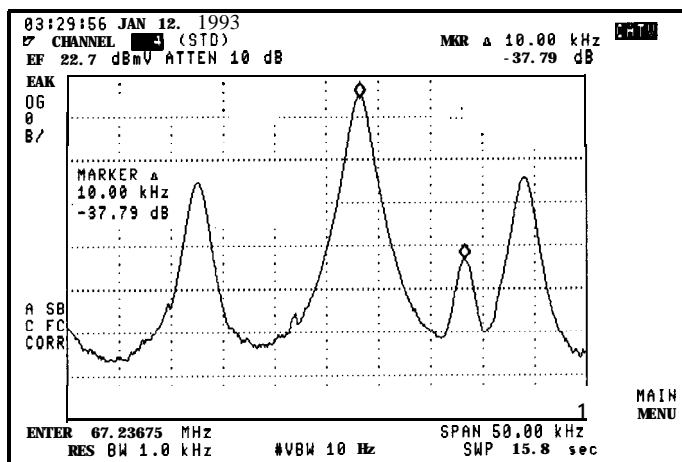

Figure 5-14. View Co-Channel



System Measurements
Menu Map and
Softkey Descriptions

System Measurements Menu Map and Softkey Descriptions

What You'll Find in This Chapter

This chapter contains the menu map and descriptions of the softkey functions used in system measurements mode. This chapter contains the following sections:

- system measurements menu map
- system measurements softkey descriptions

System Measurements Menu Map

The following menu maps are a graphic representation of all system measurement softkeys and how they are accessed.

System Measurements Menu Map

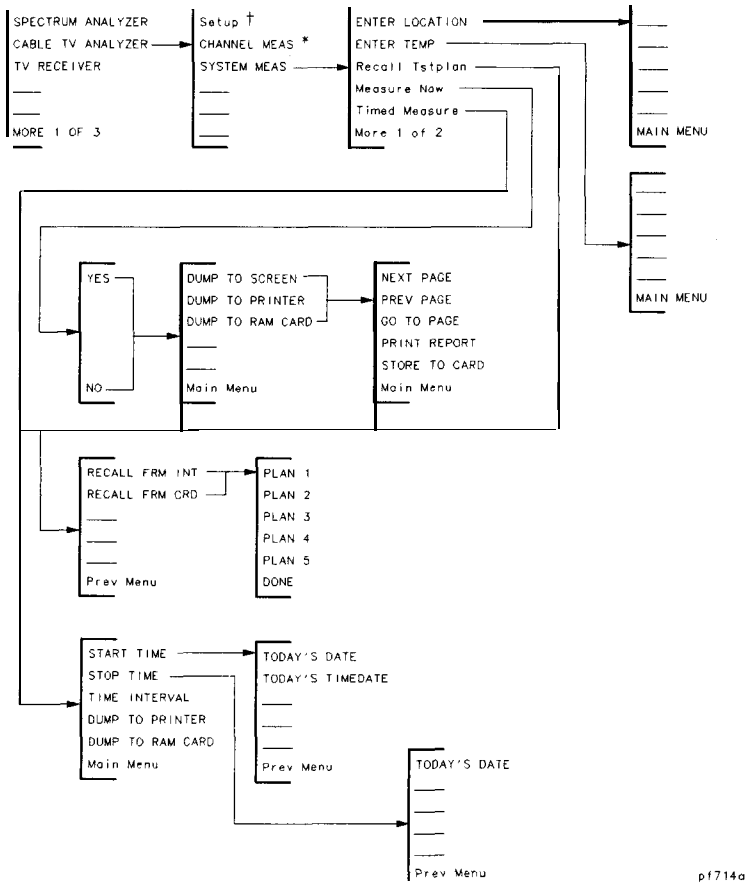
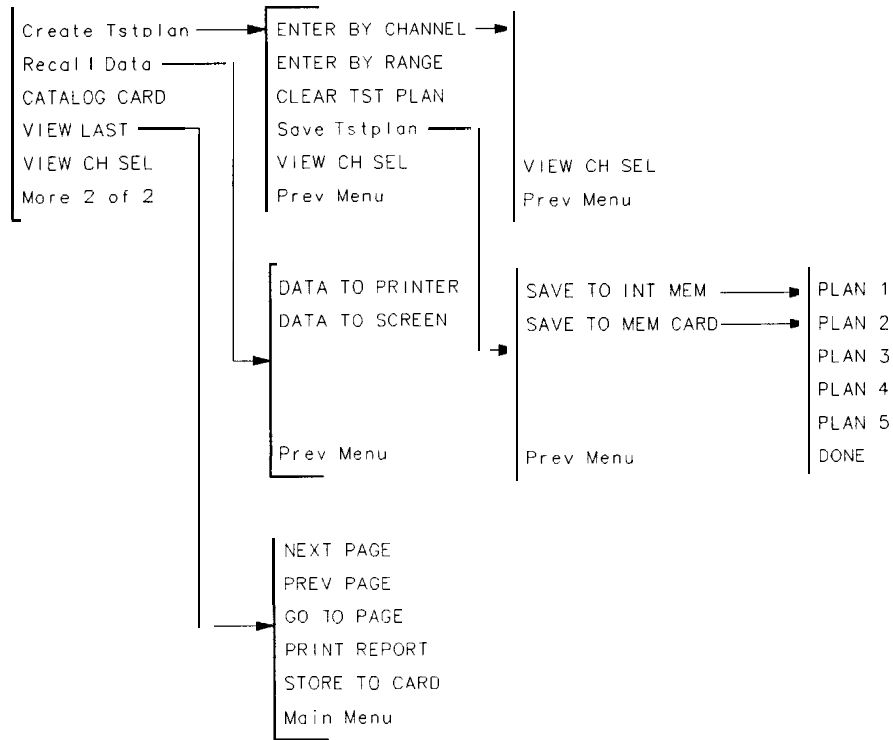

Figure 6-1. System Measurements Menu 1 of 2

* The **CHANNEL MEAS** softkey menus are found in Chapter 5.

† The **Setup** softkey menu is found in Chapter 7.



pf715a

Figure 6-2. System Measurements Menu 2 of 2

System Measurements Softkey Function Descriptions

This section contains the descriptions of the system measurements softkey functions. The functions are listed alphabetically according to the softkey labels.

ABORT Description

Allows you to stop the measurement.

It may take several seconds for the measurement to end after ABORT has been pressed.

ALL TESTS Description

Allows you to select all tests for the currently selected channel.

Press CABLE TV ANALYZER, SYSTEM MEAS, More 1 of 2, Create TstPlan, ENTER BY CHANNEL or ENTER BY RANGE, YES or NO to access ALL TESTS .

CATALOG CARD Description

Allows you to view a listing of the files stored on a RAM card or a ROM card.

Figure 6-3 shows the catalog listing of a RAM card with test data files stored on it. Table 6-1 explains the different items in the catalog listing.

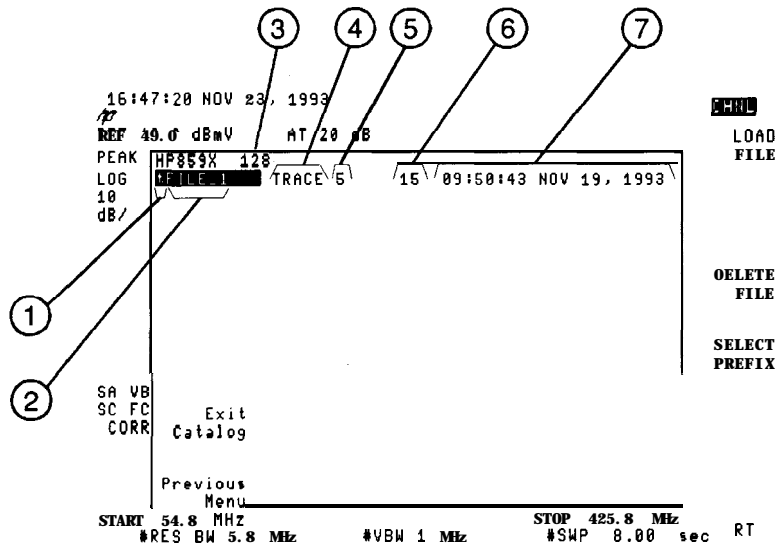

Figure 6-3. An Example of Cataloging a RAM Card

Table 6-1. Cataloging a Memory Card

Number	Item	Description
1	File type	A file type is assigned to every file that is saved on a RAM card. The "t" indicates the file is a trace data file. (The test data and test plans are stored as trace data files.) The "d" indicates the file is a downloadable program file. (The HP 85721A personality is stored as a downloadable program file.)
2	File name	Every file on the RAM card has a file name. The file name consists of the file type, a prefix, and the file number. When you store test data, the prefix is set to "FILE."
3	Total number of records	Displays the total number of records on the memory card. The number of records times 256 (bytes per record), divided by 1024 (bytes per kilobyte) yields the size of the memory card in kilobytes.
4	Data type	This field describes the file type as follows: "AMP" is for the amplitude correction factor file type, "DLP" is for the downloadable program file type, "LIMIT" is for the limit-line file type, "STATE" is for the instrument state file type, and "TRACE" is for the trace data file type.
5	Starting address	This is the RAM card address for the beginning of the file.
6	File length	The file length number represents the number of records in the file. To determine the available space left on a memory card, subtract the sum of this column from the total number of records. For example, the sum of the number of records for the 3 files that are shown in Figure 6-1 is 187. The total number of records for the memory card is 512, so the available number of records on the memory card is approximately 325.
7	Time of creation	The time and date that the file was created.

Press CABLE TV ANALYZER, SYSTEM MEAS , More 1 of 2 to access CATALOG CARD.

See Also "Cataloging a RAM Card" in Chapter 3.

CLEAR TESTS Description

Allows you to clear all selected tests for the current channel. Press CABLE TV ANALYZER, SYSTEM **MEAS** , More 1 of 2, Create **TstPlan** , ENTER BY CBANNEL or ENTER BY RANGE , YES or NO to access CLEAR TESTS

CLEAR TST PLAN Description

Allows you to clear the current test plan.

CLEAR TST PLAN clears the current test plan by removing the channel numbers and the tests for those channels from the current test plan.

CLEAR TST PLAN does *not* do any of the following:

- Delete any of the test plans that have been saved in analyzer memory (plans 1 through 5).
- Delete any of the test plans that have been saved on a RAM card.
- Delete the location code (if one was entered).
- Delete the temperature entry (if one was entered).

Press CABLE TV ANALYZER , SYSTEM **MEAS** , More 1 of 2 , Create **TstPlan** to access CLEAR TST PLAN

See Also

“Clearing the Current Test Plan” in Chapter 3.

Create TstPlan Description

Allows you to access the functions used for building a test plan. Pressing Create **TstPlan** accesses ENTER BY CHANNEL , ENTER BY RANGE, Save **TstPlan** , VIEW CH SEL , and Prev Menu.

Pressing CABLE TV ANALYZER SYSTEM MEAS , More 1 of 2 accesses Create **TstPlan**.

DATA TO PRINTER Description

Allows you to retrieve the test data from a RAM card file and send it to a printer to be printed. (The printer needs to be connected to the analyzer.)

Figure 6-4 shows an example printout. Table 6-2 explains the different items on a printout.

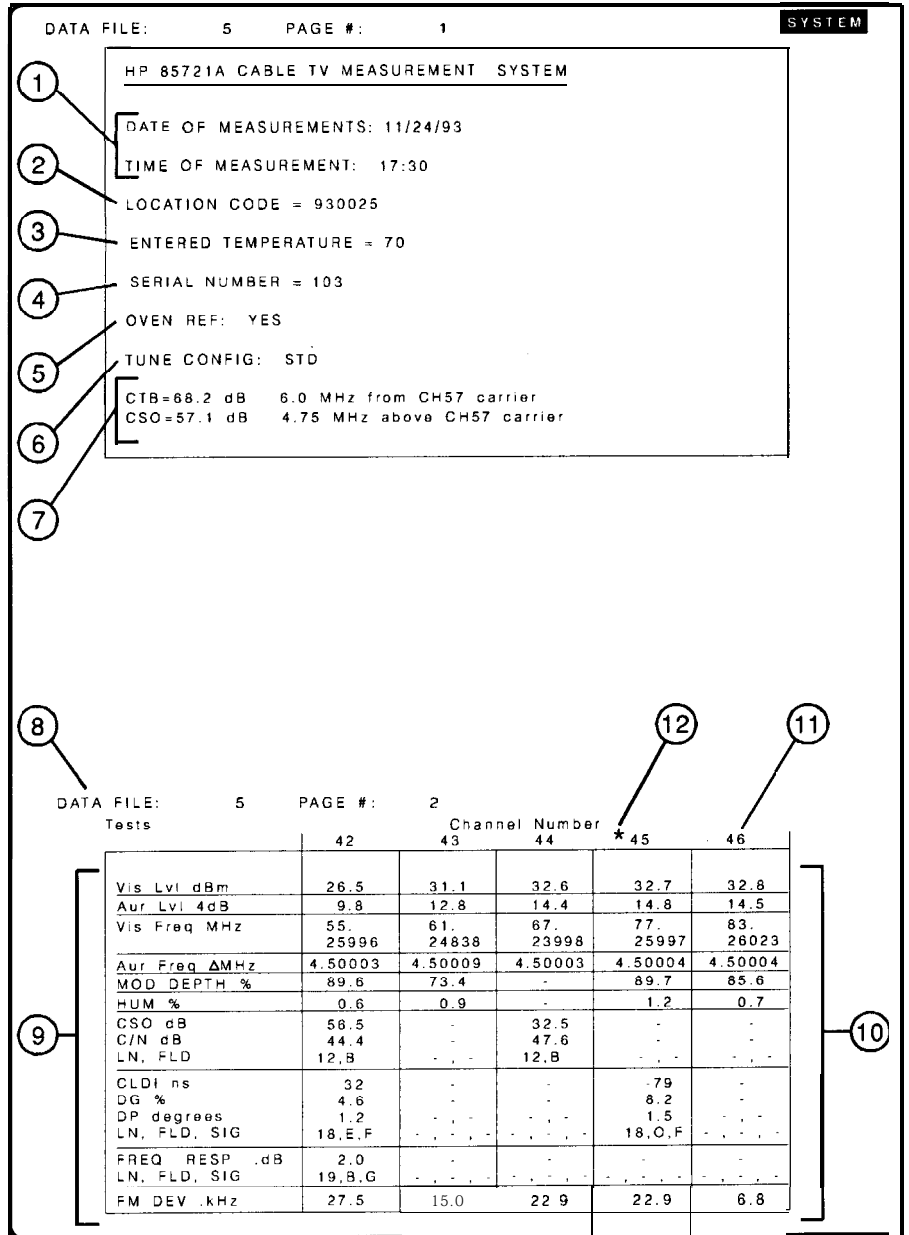

Figure 6-4. An Example Printout

Table 6-2. Information Contained in a Printout

Number	Description
1	Date and time the measurements were begun.* (Time is given in a 24-hour format.†
2	The location code.†
3	The temperature.*
4	The analyzer serial number.†
5	Whether or not the spectrum analyzer had an oven reference.+ The oven reference is available as an option (Option 004) for HP 8590 E-Series spectrum analyzers and is standard on the HP 8591C analyzer.
6	The tune configuration.
7	The results of the composite triple beat testing (if CTB testing was selected when the testing was performed).
8	The file number of test data file.
9	The tests.
10	The test results. An entry with a dash ['-'] indicates that the test was not performed.
11	The channel number.
12	The asterisk indicates that the channel was selected as a scrambled channel.
The location code and temperature entry are entered by the operator. The information for this entry is from the analyzer used to do the testing.	

Press CABLE TV ANALYZER, SYSTEM MEAS , More 1 of 2 , Recall Data to access DATA TO PRINTER

See Also “Step 3. Install a printer” in Chapter 1.

DONE Description

Allows you to indicate that you have finished making your selection.
(The DONE softkey should not be confused with the DONE programming command.)

DUMP TO PRINTER Description

Allows you to have the test results sent to a printer when using Measure Now or Timed Measure. The printer needs to be connected to the analyzer.

Figure 6-5 shows an example printout. Table 6-3 explains the different items on a printout.

Press Measure Now , Yes or No , or Timed Measure to access DUMP TO PRINTER.

System Measurements Menu Map and Softkey Descriptions
 System Measurements **Softkey** Function Descriptions

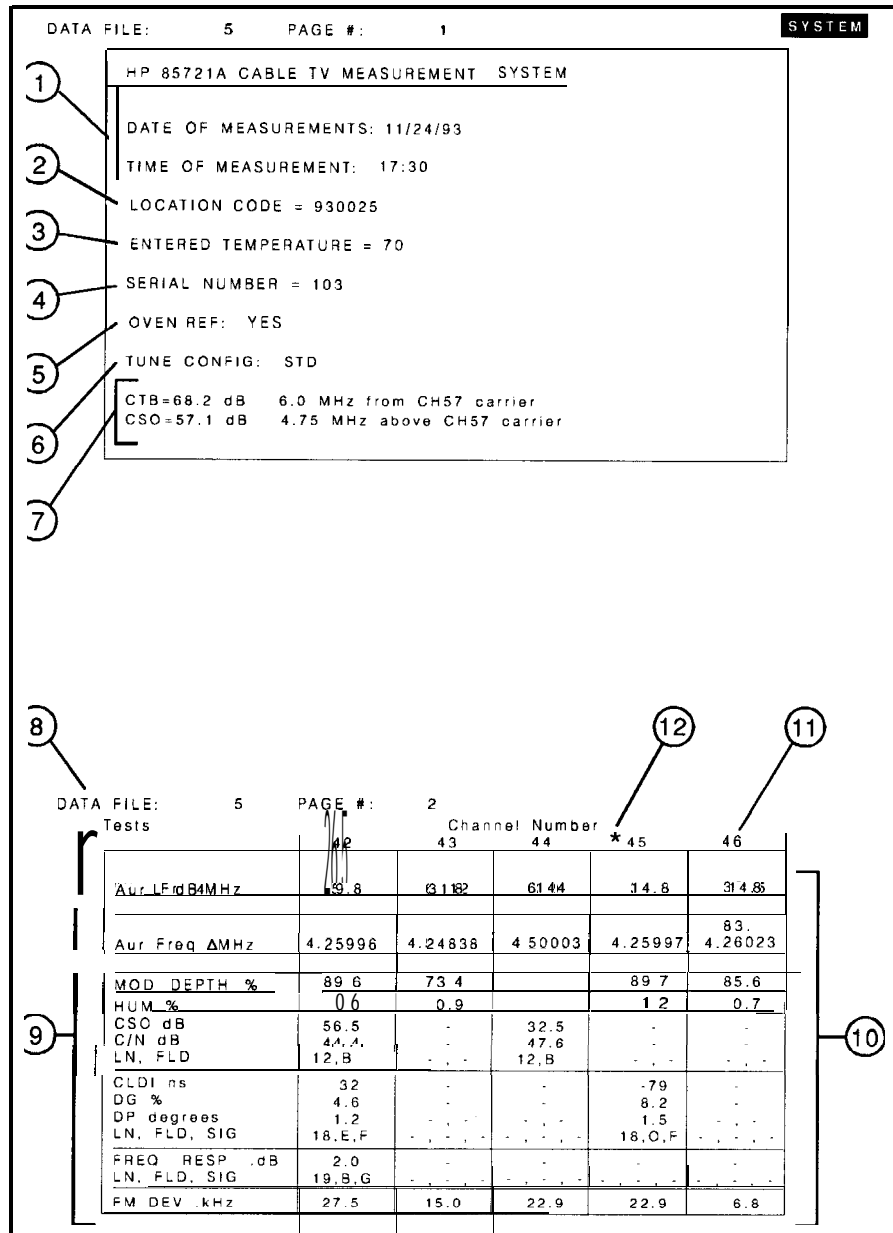

Figure 6-5. An Example Printout

Table 6-3. information Contained in a Printout

Number	Description
1	Date and time the measurements were begun." {Time is given in a N-hour format.1
2	The location code."
3	The temperature."
4	The analyzer serial number.†
5	Whether or not the spectrum analyzer had an oven reference.† The oven reference is available as a option [Option 0041 for HP 8590 E-Series spectrum analyzers and is standard on the HP 8591C analyzer.
6	The tune configuration.
7	The results of the composite triple beat testing [if CTB testing was selected when the testing was performed].
8	The file number of test data file.
9	The tests.
10	The test results. An entry with a dash ('-') indicates that the test was not performed.
11	The channel number.
12	The asterisk indicates that the channel was selected as a scrambled channel.
* The location code and temperature entry are entered by the operator. † The information for this entry is from the analyzer used to do the testing.	

See Also

- “Step 3. Install a printer” in Chapter 1.
- “Step 6. Make the measurements now” in Chapter 3.
- “Making Timed System Measurements” in Chapter 3.

DUMP TO RAM CARD Description

Allows you to store the test results on a RAM card when using Measure Now or Timed Measure. The RAM card must be formatted and ready for use to store the test data. A test data file is stored on the RAM card for each instance of a measurement set for Timed Measure. Up to 34 files of test data can be stored on a 128 kilobyte or 8 files on a 32 kilobyte RAM card. A file name is created for each file of test data stored on a RAM card. The file name for the test data consists of a "t", "FILE," an underscore ("_"), and a number (between 1 and 40) that you enter. If you use the same number as an existing file stored on a RAM card, it overwrites the file on the RAM card. For Timed Measure, file numbers begin with the number you enter and are automatically incremented with each measurement set.

Overwriting a file does not change the time and date entry shown when the RAM card is cataloged. If you want the time and date to reflect when the new file was written to the RAM card, you need to delete the existing file, then save the new file.

If there is not enough room on the RAM card, you need to delete unwanted files from the RAM card. To delete files from the RAM card, use DELETE FILE (deletes a single file from the RAM card). DELETE FILE is found under the **RECALL** hardkey.

The RAM card can be cataloged by using CATALOG CARD

Press Measure Now, Yes or No, or Timed Measure to access DUMP TO RAM CARD .

See Also

“Formatting a RAM card” in Chapter 3.
“Step 6. Make the measurements now” in Chapter 3.
The description of Recall Data in this chapter.
“Making Timed System Measurements” in Chapter 3.

DUMP TO SCREEN Description

Allows you to send test results to the analyzer screen. If data is sent to the screen, the following options are available:

- **NEXT PAGE** displays the next page of test results.
- **PREV PAGE** displays the previous page of test results.
- **GOTO PAGE** displays selected page number.
- **PRINT REPORT** prints a test results report.
- **STORE TO CARD** stores test results to a RAM card.

Press **CABLE TV ANALYZER** , **SYSTEM MEAS** , Measure Now , Yes or No to access **DUMP TO SCREEN**

See Also

“Step 6. Make the measurements now” in Chapter 3.

ENTER BY CHANNEL Description

Allows you to enter channels individually or to edit the test plan. A maximum of 158 channels (channel numbers 0, 2 through 158) can be entered into a test plan. Valid channels using Option 107 include 2 through 134.

Press CABLE TV ANALYZER , SYSTEM MEAS , More 1 of 2 ,
Create **TstPlan** to access ENTER BY CHANNEL.

See Also

“Step 1. Select an individual channel” in Chapter 3.

ENTER BY RANGE Description

Allows you to enter channels as a range of channel numbers. Unlike ENTER BY CHANNEL , you cannot use ENTER BY RANGE to edit or delete a channel. A maximum of 158 channels (channel numbers 0, 2 through 158) can be entered into a test plan.

Press Test Plan to access ENTER BY CHANNEL

See Also

“Step 2. Select a range of channels” in Chapter 3.

ENTER LOCATION Description

Allows you to enter a location code. You do not have to enter a location code; it is only for your convenience to help you keep track of where the test data originated. The location code can be up to seven digits long.

If you do not enter a location code, the default location code will be either the location code that was previously entered or, if a location code was not previously entered, a "0."

On the RAM card, the location code is stored in the test data file. The location code is printed when the test data is printed.

In analyzer memory, the location code is not stored with the current test plan in plans 1 through 5. The location code is stored in nonvolatile analyzer memory, however. Storing the location code in nonvolatile memory means that once a location code is entered, it will be used as the location code until a new location code is entered or the HP 85721A personality program is deleted from analyzer memory.

Pressing CABLE TV ANALYZER, SYSTEM **MEAS** accesses ENTER LOCATION

See Also

"Step 3. Enter the location code" in Chapter 3.

ENTER TEMP Description

Allows you to enter the temperature. You can enter a number from -999 to +999. The temperature is entered without Celsius or Fahrenheit units. The analyzer does not measure the temperature. You must provide the temperature reading.

You do not have to enter a temperature; it is only for your convenience. If you do not enter a temperature, the default temperature entry will either be the temperature that was previously entered or, if a temperature reading was not previously entered, a "0."

On the RAM card, the temperature entry is stored in the test data file. The temperature entry is printed when the test data is printed.

In analyzer memory, the temperature entry is not stored with the current test plan in plans 1 through 5. The temperature entry is stored in nonvolatile analyzer memory, however. Storing the temperature entry in nonvolatile memory means that once a temperature is entered, it will be used as the temperature until a new temperature is entered or the HP 85721A personality program is deleted from analyzer memory.

Pressing CABLE TV ANALYZER , SYSTEM **MEAS** accesses ENTER TEMP .

See Also

“Step 4. Enter the temperature” in Chapter 3.

GOTO PAGE Description

Allows you to select a specific page of on-screen test results to view. Press CABLE TV ANALYZER, SYSTEM **MEAS** , Measure Now , Yes or No , **DUMP** TO SCREEN to access GOTO PAGE , or press More 1 of 2 , VIEW LAST (if a measurement was previously made).

See Also

“Step 6. Make the measurements now” in Chapter 3.

Main Menu Description

Allows you to access the main menu of the system measurement mode. The main menu contains the following softkeys: ENTER LOCATION , ENTER TEMP , Recall **TstPlan** , Measure Now , Timed Measure, Create **TstPlan** , Recall Data, CATALOG CARD, VIEW LAST, VIEW CH SEL .

The main menu of the system measurement mode can also be accessed by pressing **MODE**, CABLE TV ANALYZER , SYSTEM **MEAS**

Measure Now Description

Accesses the functions that allow you to initiate the testing immediately (instead of initiating testing at a later time) and send the test results to the screen, a printer, or to a RAM card.

Pressing Measure Now will display a screen that allows the option of selecting CTB testing. Then, the DUMP TO SCREEN , DUMP TO PRINTER , DUMP TO CARD , and Main Menu softkeys are accessed.

Pressing CABLE TV ANALYZER , SYSTEM **MEAS** accesses Measure Now

See Also

“Step 3. Install a printer” in Chapter 1.

NEXT PAGE Description

Allows you to select the next page of on-screen test results.

Press CABLE TV ANALYZER, SYSTEM **MEAS** , Measure Now , Yes or No , **DUMP TO SCREEN** to access NEXT PAGE.

See Also

“Step 6. Make the measurements now” in Chapter 3.

NO Description

Allows you to select not to do the function. If you press CLEAR TST PLAN and then press NO , you have selected not to clear the current test plan from analyzer memory. If you enter a channel by using ENTER BY CHANNEL or ENTER BY RANGE and then press NO , the channel or range of channels will be treated as channels that are not scrambled.

NO is accessed either by pressing CLEAR TST PLAN or by entering a channel number with ENTER BY CHANNEL or ENTER BY RANGE .

PLAN 1 Description

Allows you to select test plan 1 as the test plan number for either saving the current test plan or recalling a previously saved test plan.

Saving the current test plan in plan 1

Saving the current test plan overwrites any test plan previously saved in plan 1. When you save the current test plan in test plan 1, it is stored in trace register 6.

The channel numbers, tests, scrambling status, channel tuning configuration, quiet line number, frequency response line number, test signal line number, and field selection are saved in the test plan.

The location code, the temperature, the selection of CTB testing, and the setting for an external pad (EXT PAD YES NO) are not stored with the test plan but are stored in nonvolatile analyzer memory and are retained until changed.

Recalling a test plan from plan 1

Recalling a test plan overwrites the current test plan. If you do not want the current test plan to be overwritten, save the current test plan before recalling a test plan. When you recall the a test plan from test plan 1, it is recalled from trace register 6.

The location code, the temperature, the selection of CTB testing, and the setting for an external pad (EXT PAD YES NO) are not recalled with the test plan. Before initiating testing with a recalled test plan, you may want to do the following:

- Enter the location code.
- Enter the temperature reading.
- Change the setting of the CTB testing (in Setup menu).
- Change the setting of the external pad compensation (in Setup menu).

Press CABLE TV ANALYZER, SYSTEM **MEAS** , More 1 of 2,
Create TstPlan, Save TstPlan, then SAVE TO INT MEM to
access PLAN 1 . Or, press CABLE TV ANALYZER , SYSTEM **MEAS** ,
Recall TstPlan , RECALL FRM **INT** to access PLAN 1

See Also

“Step 3. Save the current test plan in internal memory” in Chapter 3.
“Step 5. Recall a test plan” in Chapter 3.

PLAN 2 Description

Allows you to select test plan 2 as the test plan number for either saving the current test plan or recalling a previously saved test plan.

The operation of PLAN 2 is identical to PLAN 1 except that the test plan is stored in and recalled from trace register 7.

PLAN 3 Description

Allows you to select test plan 3 as the test plan number for either saving the current test plan or recalling a previously saved test plan.

The operation of PLAN 3 is identical to PLAN 1 except that the test plan is stored in and recalled from trace register 8.

PLAN 4 Description

Allows you to select test plan 4 as the test plan number for either saving the current test plan or recalling a previously saved test plan.

The operation of PLAN 4 is identical to PLAN 1 except that the test plan is stored in and recalled from trace register 9.

PLAN 5 Description

Allows you to select test plan 5 as the test plan number for either saving the current test plan or recalling a previously saved test plan.

The operation of PLAN 5 is identical to PLAN 1 except that the test plan is stored in and recalled from trace register 10.

Prev Menu Description

Allows you to access the previous system measurement menu.

PREV PAGE Description

Allows you to select the previous page of on-screen test results.

Press CABLE TV ANALYZER, SYSTEM **MEAS** , Measure Now , Yes or No,
DUMP TO SCREEN to access PREV PAGE

See Also

“Step 6. Make the measurements now” in Chapter 3.

PRINT REPORT Description

Allows you to print a report of the currently displayed test results.

Press CABLE TV ANALYZER, SYSTEM **MEAS** , Measure Now, Yes or No,
DUMP TO SCREEN to access PRINT REPORT

See Also

“Step 6. Make the measurements now” in Chapter 3.

Recall Data Description

Allows you to access DATA TO PRINTER and DATA TO SCREEN.

DATA TO PRINTER sends the test results from a file on a RAM card to a printer. DATA TO SCREEN sends the test results from a file on a RAM card to the screen.

Press CABLE TV ANALYZER , SYSTEM **MEAS** , More 1 of 2 to access Recall Data.

See Also “Recalling Test Data from the RAM Card” in Chapter 3.

RECALL FRM CRD Description

Allows you to recall a previously saved test plan from a RAM card.

Recalling a test plan overwrites the current test plan. If you do not want the current test plan to be overwritten, save the current test plan before recalling a test plan.

Press CABLE TV ANALYZER, SYSTEM **MEAS** , Recall **TstPlan** to access RECALL FRM CRD

Sea Also “Recalling a Test Plan from a RAM Card” in Chapter 3

RECALL FRM INT Description

Allows you to recall a previously saved test plan (from plans 1 through 5) from analyzer memory.

Recalling a test plan overwrites the current test plan. If you do not want the current test plan to be overwritten, save the current test plan before recalling a new one. See “Step 3. Save the current test plan in internal memory” in Chapter 3 for more information.

The test plans are saved in trace registers 6 through 10.

The channel numbers, tests, scrambling status, channel tuning configuration, quiet line number, frequency response line number, test signal line number, and Eeld selection are saved in the test plan.

The location code, the temperature, the selection of CTB testing, and the setting for an external pad (EXT PAD YES NO) are not stored with the test plan but are stored in nonvolatile analyzer memory and are retained until changed.

Before initiating testing with a recalled test plan, you may want to do the following:

- Enter the location code.
- Enter the temperature reading.
- Change the setting of the external pad function (in Setup menu).

Pressing CABLE TV ANALYZER, SYSTEM MEAS , Recall **TstPlan** accesses RECALL FRM INT

See Also

“Step 5. Recall a test plan” in Chapter 3.

Recall TstPlan Description

Allows you to access the softkeys used to recall a previously saved test plan from analyzer memory, or from a RAM card.

Recalling a test plan overwrites the current test plan. If you do not want the current test plan to be overwritten, save the current test plan before recalling a new one. Press CABLE TV ANALYZER , SYSTEM **MEAS** to access Recall **TstPlan** .

See Also

“Step 5. Recall a test plan” in Chapter 3.
“Recalling a Test Plan from a RAM Card” in Chapter 3.

SAVE TO INT MEM Description

Allows you to save the current test plan in analyzer memory.

Saving a test plan overwrites any previously saved test plan of the same test plan number.

Up to five test plans can be saved in analyzer memory. The test plans are saved in nonvolatile analyzer memory, in trace registers 6 through 10.

The channel numbers, tests, scrambling status, channel tuning configuration, quiet line number, frequency response line number, test signal line number, and Eeld selection are saved in the test plan.

The location code, the temperature, the selection of CTB testing, and the setting for an external pad (EXT PAD YES NO) are not stored with the test plan but are stored in nonvolatile analyzer memory and are retained until changed.

Pressing CABLE TV ANALYZER , SYSTEM **MEAS** , More 1 of 2 ,
Save TstPlan accesses SAVE TO INT MEM

See Also “Step 3. Save the current test plan in internal memory” in Chapter 3.

SAVE TO MEM CRD Description

Allows you to store the on-screen test results to a RAM card. Press CABLE TV ANALYZER, SYSTEM **MEAS** , Measure Now, Yes or No, DUMP TO SCREEN to access STORE TO CARD.

See Also “Step 6. Make the measurements now” in Chapter 3.

Save TstPlan Description

Allows you to access SAVE TO INT MEM and SAVE TO MEM CRD

Pressing CABLE TV ANALYZER , SYSTEM **MEAS** , More 1 of 2 ,
Create TstPlan accesses Save TstPlan.

See Also “Step 3. Save the current test plan in internal memory” in Chapter 3.

START TIME Description

Allows you to specify the time and the date when testing is to begin for timed measurements. The time is specified in 24-hour, hour, minute format; the date is specified in year, month, and day format. If you do not specify a time, the current time is used. If you do not specify a date, the current date is used. If you specify a time earlier than the current time, the current time is used. If you specify a date earlier than the current date, the current date is used. If the date or time setting of the analyzer is incorrect, see “If the wrong date or time is displayed” in Chapter 4.

Pressing CABLE TV ANALYZER , SYSTEM **MEAS** , Timed Measure accesses START TIME.

See Also “Making Timed System Measurements” in Chapter 3.

STOP TIME Description

Allows you to specify the time and the date to end the testing for a timed measurement. The time is specified in 24-hour, hour, minute format; the date is specified in year, month, and day format. If you enter a stop time that is 24 hours or greater, the stop time will be set to 23 hours and 59 minutes.

Pressing CABLE TV ANALYZER, SYSTEM **MEAS** , Timed Measure accesses STOP TIME.

See Also “Making Timed System Measurements” in Chapter 3.

SYSTEM MEAS Description

Accesses the system measurement mode. When the analyzer is in the system measurement mode, SYSTEM is displayed in the upper right corner of the analyzer display.

Pressing SYSTEM **MEAS** accesses the following: ENTER LOCATION , ENTER TEMP , Recall **TstPlan** , Measure Now , Timed Measure , Create **TstPlan** , Recall Data, CATALOG CARD , **VIEW LAST**, and VIEW CR SEL

Accessing the system measurement mode automatically changes the input impedance setting of a spectrum analyzer to 75 Ω . (The setting of the input impedance is usually controlled by INPUT Z 50 75 .) For spectrum analyzer's with 50 Ω impedance, changing the input impedance with INPUT Z 50 75 minimizes the impedance mismatch, but does not eliminate the impedance mismatch unless a 50 Ω to 75 Ω external matching pad is used.

Press **(MODE)**, CABLE TV ANALYZER to access SYSTEM **MEAS**

See Also

“Step 5. Start channel or system mode of operation” in Chapter 1.

Timed Measure Description

Allows you to access the functions that you can use to initiate the testing at a later time.

When you press Timed Measure , you access a menu with the following softkeys: START TIME , STOP TIME , TIME INTERVAL , DUMP TO PRINTER , DUMP TO RAM CARD , and Main Menu

Pressing CABLE TV ANALYZER SYSTEM **MEAS** accesses Timed Measure .

See Also

“Making Timed System Measurements” in Chapter 3.

TIME INTERVAL Description

Allows you to specify the time interval between the starting of testing for a timed measurement. The time interval is specified in 24-hour, hour, minute format. The maximum time interval is 99 hours.

If you do not specify a time interval, the time interval is set to zero. When the time interval is set to zero, testing will begin immediately after the previous tests have been completed.

When specifying a time interval, you need to specify a time interval that is at least long enough to allow the analyzer to complete the testing before beginning testing again. Here are some general guidelines for estimating how long it takes the analyzer to test one channel:

- It takes approximately 5 minutes to test a channel that is not scrambled with all of the tests selected for that channel.
- It takes approximately 2 minutes to test a scrambled channel with tests 1, 2, 3, 6, and 9 selected for that channel.

So the time interval that you specify (in minutes) should, at the least, exceed the number of channels that you are testing plus 10 minutes.

Press CABLE TV ANALYZER, SYSTEM **MEAS** , Timed Measure to access TIME INTERVAL

See Also

“Making Timed System Measurements” in Chapter 3.

TODAY'S DATE Description

Allows you to select the current date as the start date or stop date for timed measurements.

When you press TODAY'S DATE , the analyzer uses the date setting of the spectrum analyzer. If the date or time setting of the analyzer is incorrect, see "If the wrong date or time is displayed" in Chapter 4.

Press **CABLE TV ANALYZER**, **SYSTEM MEAS** , Timed Measure , **START TIME** to access TODAY'S DATE as the start date for the timed measurement. Press Timed Measure , **STOP TIME** to access TODAY'S DATE as the stop date for the timed measurement.

See Also "Making Timed System Measurements" in Chapter 3.

TODAY'S TIMEDATE Description

Allows you to select the current time and date as the start time and date for timed measurements.

When you press TODAY'S **TIMEDATE** , the analyzer uses the time and date setting of the analyzer. If the date or time setting of the analyzer is incorrect, see "If the wrong date or time is displayed" in Chapter 4.

Press **CABLE TV ANALYZER**, **SYSTEM MEAS** , Timed Measure, **START TIME** to access TODAY'S **TIMEDATE** .

See Also "Making Timed System Measurements" in Chapter 3.

VIEW CH SEL Description

Allows you to view the selected channels of the current test plan

VIEW LAST Description

Allows you to view the last test results on the analyzer screen. Upon being sent to the screen, the following options are available:

- NEXT PAGE displays the next page of test results.
- PREV PAGE displays the previous page of test results.
- **GOTO** PAGE displays selected page number.
- PRINT REPORT prints a test results report.
- STORE TO CARD stores test results to a RAM card.

Press CABLE TV ANALYZER , SYSTEM **MEAS** , More 1 of 2 to access VIEW LAST.

YES Description

Allows you to confirm that you want to perform the function. If you press CLEAR TST PLAN and then press YES , you have selected to clear the current test plan from analyzer memory. If you enter a channel by using ENTER BY CHANNEL or ENTER BY RANGE and then press YES, the channel or range of channels will be treated as scrambled channels. If you press Measure Now and then press YES , CTB testing will be performed.

YES is accessed by pressing CLEAR TST PLAN , or entering a channel number with ENTER BY CHANNEL or ENTER **BY** RANGE, or by pressing Measure Now.

System Measurements Menu Map and Softkey Descriptions
System Measurements **Softkey** Function Descriptions



TV Receiver, Setup, and
AUX CTRL Menu Maps and
Softkey Descriptions

TV Receiver, Setup, and AUX CTRL Menu Maps and Softkey Descriptions

What You'll Find in This Chapter

This chapter contains the menu maps and descriptions of the TV receiver and default configuration softkeys, as well as the monitor TV softkeys under the **AUX CTRL** hardkey. This chapter contains the following sections:

- TV RECEIVER menu map
- setup menu map
- **AUX CTRL** menu map
- softkey descriptions

TV RECEIVER Menu Map

The following menu map shows the TV receiver softkeys and how they are accessed.

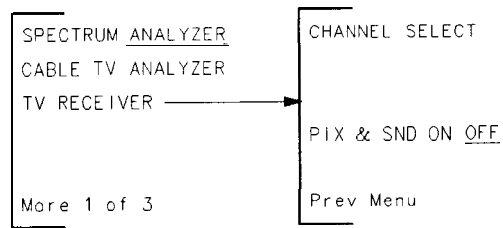

pf718a

Figure 7-1. TV RECEIVER Menu Map

Setup Menu Map

The following menu map shows the default configuration softkeys and how they are accessed.

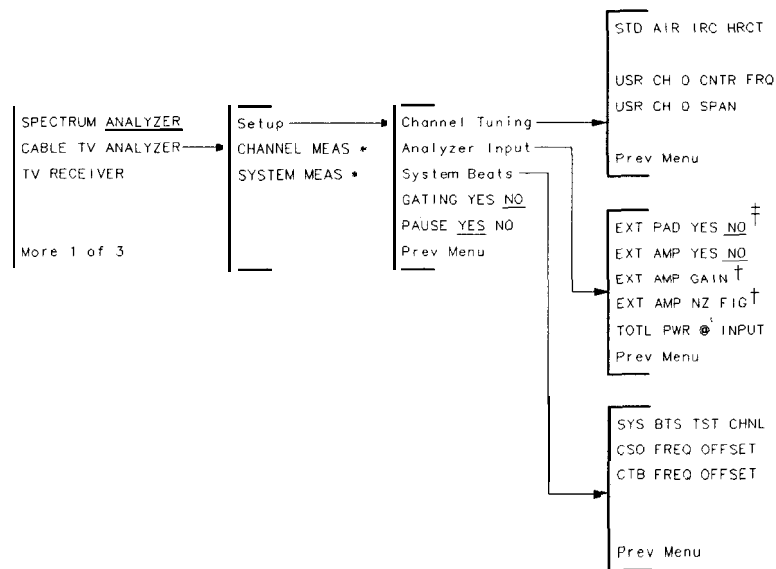

pf716a

Figure 7-2. Setup Configuration Menu Map

* The **CHANNEL MEAS SYSTEM MEAS** softkey menus are found in Chapters 5 and 6 respectively.

† These softkeys only appear when **EXT AMP YES NO** is set to YES.

‡ Only appears with 50Ω input analyzers.

AUX CTRL Menu Map

The following menu map shows the TV receiver softkeys found under the **AUX CTRL** front-panel hardkey.

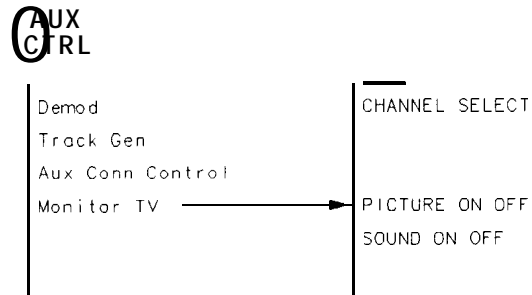

pf717a

Figure 7-3. **AUX CTRL** Menu Map

Softkey Descriptions

This section contains the descriptions of the TV RECEIVER, **AUX CTRL**, and Setup softkey functions. The functions are listed alphabetically according to the softkey labels.

AIR Description

Allows you to select the AIR tune configuration. The AIR is also called off-the-air or over-the air tune configuration. It refers to signals that are broadcast over the air and received with an antenna. The AIR frequency assignments are defined in the Federal Communications Commission's (FCC) channel identification plan, part 76.612.

If you do not select a tune configuration, the default tune configuration is the standard (STD) configuration. The choices for the tune configuration are: standard (STD), off-the-air (AIR), incrementally related carriers (IRC), harmonically related carriers (HRC), and T format.

The analyzer retains the tune configuration selection, even when power is turned off, until a new selection is made.

Press CABLE TV ANALYZER, Setup, Channel Tuning to access AIR.

See Also

“Step 1. Configure the test system” in Chapter 2.

Analyzer Input Description

Allows you to select an external pad, an external preamplifier, and measure total power at the input to the analyzer. An external 50 Ω to 75 Ω pad is used for analyzers with 50 Ω input impedances. The EXT PAD YES **NO** function compensates for amplitude loss caused by an external pad.

An external preamplifier (or the internal preamplifier in HP 8591C analyzer) is used for the carrier-to-noise test.

The external pad and preamplifier settings are stored in non-volatile analyzer memory. This means that the analyzer retains the selection, even when power is turned off, until a new selection is made.

The **TOTL PWR @ INPUT** measures the total input power and displays the result on the screen.

Press **CABLE TV ANALYZER, Setup** to access Analyzer Input

See Also

“Step 1. Configure the test system” in Chapter 2.

Softkey Descriptions

CHANNEL SELECT Description

Allows you to select a specific channel number to view in TV receiver (or monitor TV) mode. In this mode, you can view a TV picture and listen to the sound simultaneously (Option 107 required).

Press TV **RECEIVER** or press **AUX CTRL**, Monitor TV to access CHANNEL SELECT

See Also

“Step 5. Access the TV receiver mode” in Chapter 2.

Channel Tuning Description

Allows you to select the channel tuning configuration for the channels in the test plan.

The channel tuning configurations that can be selected are as follows:

- | | |
|-----|-------------------------------------|
| STD | For a standard channel format. |
| AIR | For off-the-air channel format. |
| IRC | For incrementally related carriers. |
| HRC | For harmonically related carriers. |
| T | For upstream channels. |

The default value for the channel tuning configuration is the standard (STD) channel format. In addition, the **USR CH 0 CNTR FRQ** and **USR CH 0 SPAN** softkeys allow you to define the center frequency and span for a user defined channel. This channel is then accessed by selecting channel 0 (zero). The default settings are for channel 2 (STD). These settings are stored in non-volatile analyzer memory. This means that the analyzer retains the selections, even when power is turned off, until a new selection is made.

Press **CABLE TV ANALYZER** , Setup , to access Channel Tuning

See Also “Step 1. Configure the test system” in Chapter 2.

CSO FREQ OFFSET and CTB FREQ OFFSET Description

Allows you to specify the location above or below a visual carrier to measure system CSO and system CTB. The defaults are channel 4, CTB 6 MHz above the visual carrier, and CSO 4.75 MHz above the visual carrier.

Simply press **CSO FREQ OFFSET** (CSO) and/or **CTB FREQ OFFSET** (CTB), enter a positive frequency to measure above the visual carrier or a negative frequency to measure below the visual carrier, then press **ENTER**.

Press **CABLE TV ANALYZER**, Setup , System Beats to access **CSO FREQ OFFSET** and **CTB FREQ OFFSET**.

See Also “Step 1. Configure the test system” in Chapter 3.

Softkey Descriptions

EXT AMP GAIN Description

Allows you to select the gain value of an external preamplifier for the carrier-to-noise test. The default value is 20 dB for the HP 85905A preamplifier.

The preamplifier selection is stored in nonvolatile analyzer memory. This means that the analyzer retains the selection, even when power is turned off, until a new selection is made.

Press CABLE TV ANALYZER , Setup, Analyzer Input to access EXT AMP GAIN .

See Also

“Step 1. Configure the test system” in Chapter 2.

EXT AMP NZ FIG Description

Allows you to select the noise figure value of an external preamplifier for the carrier-to-noise test. The default value is 7 dB for the HP 85905A preamplifier.

The preamplifier selection is stored in nonvolatile analyzer memory. This means that the analyzer retains the selection, even when power is turned off, until a new selection is made.

Press CABLE TV ANALYZER , Setup, Analyzer Input to access EXT AMP NZ FIG

See Also

“Step 1. Configure the test system” in Chapter 2

EXT AMP YES NO Description

Allows you to select an external preamplifier for the carrier-to-noise test. The preamplifier selection is stored in nonvolatile analyzer memory. This means that the analyzer retains the selection, even when power is turned off, until a new selection is made.

When EXT AMP YES NO is set to YES, the carrier-to-noise test uses the values entered using the EXT AMP GAIN EXT AMP NZ FIG for the calculation.

Press CABLE TV ANALYZER, Setup , Analyzer Input to access EXT AMP YES NO .

See Also

“Step 1. Configure the test system” in Chapter 2.

EXT PAD YES NO Description

EXT PAD YES NO can be used to compensate for the amplitude loss caused by using a 50 Ω to 75 Ω external matching pad. (A 50 Ω to 75 Ω external matching pad is used to match the signal from a 75 Ω impedance system to a spectrum analyzer with a 50 Ω impedance input.) The external pad function compensates for the 5.8 dB amplitude loss of the external pad by setting the spectrum analyzer's reference level offset to 5.8 dB.

If you are using a spectrum analyzer with 50 Ω input impedance but are not using an external matching pad, the cable TV analyzer mode will compensate for most of the impedance mismatch, but amplitude measurements can have up to k0.2 dB error caused by the uncompensated mismatch over the frequency range.

This function is set to NO when the HP 85721A personality is loaded into analyzer memory.

Softkey Descriptions

In spectrum analyzer memory, the setting of the external pad function entry is not stored with the current test plan in plans 1 through 5. The setting of the external pad function is stored in nonvolatile spectrum analyzer memory, however. Storing the setting in nonvolatile memory means that once the external pad function is set to YES, it will remain set to YES until you change the setting or delete the HP 85721A personality program from analyzer memory.

Press CABLE TV ANALYZER , Setup, Analyzer Input to access
EXT PAD YES NO

See Also

“Step 2. Connect the signal to the analyzer” in Chapter 2.

HRC Description

Allows you to select the harmonically related carriers (HRC) tune configuration. HRC is the channel tuning configuration in which the frequency of each video carrier is a multiple of 6 MHz.

If you do not select a channel tuning configuration, the default configuration is the standard (STD) configuration. The choices for the channel tuning configuration are: standard (STD), off-the-air (AIR), incrementally related carriers (IRC), harmonically related carriers (HRC), and T format.

The analyzer retains the channel tuning configuration selection, even when power is turned off, until a new selection is made.

Press CABLE TV ANALYZER , Setup, Channel Tuning to access HRC

See Also

“Step 1. Configure the test system” in Chapter 3.

IRC Description

Allows you to select the incrementally related carriers (IRC) channel tuning configuration.

If you do not select a channel tuning configuration, the default configuration is the standard (STD) configuration. The choices for the channel tuning configuration are: standard (STD), off-the-air (AIR), incrementally related carriers (IRC), harmonically related carriers (HRC), and T format.

The analyzer retains the channel tuning configuration selection, even when power is turned off, until a new selection is made.

Press CABLE TV ANALYZER , Setup , Channel Tuning to access IRC .

See Also

“Step 1. Configure the test system” in Chapter 2.

Monitor TV Description

Allows you to access the TV receiver mode. This feature is the same as the TV RECEIVER mode of operation except that it is accessed from a front-panel hardkey.

Press **AUX CTRL** to access Monitor TV

See Also

“Step 5. Access the TV receiver mode” in Chapter 2.

Softkey Descriptions

PICTURE ON OFF Description

Allows you to turn the TV picture on and off. This feature is the same as the TV RECEIVER mode of operation except that it is accessed from a front-panel hardkey.

Press **AUX CTRL**, Monitor TV to access **PICTURE ON OFF** .

See Also “Step 5. Access the TV receiver mode” in Chapter 2.

PIX &SND ON OFF Description

Allows you to view the TV picture and listen to the sound simultaneously. This feature allows you to quickly identify picture quality problems such as noise, distortion, hum, and ingress. Select a channel by pressing CHANNEL SELECT , entering a TV channel number, then pressing **PIX &SND ON OFF** To exit this mode, press any softkey.

Press TV RECEIVER to access **PIX &SND ON OFF**

See Also “Step 5. Access the TV receiver mode” in Chapter 2

Setup Description

Allows you to access the softkeys used to set up defaults for channel tuning configuration, input configuration, non-interfering RF and video measurement configurations, and channel to test for system beats.

The channel tuning configuration softkeys include STD , AIR, IRC , HRC , T ,
USR CH 0 CNTR **FRQ** , and USR CH 0 SPAN

The analyzer input configuration softkeys include EXT PAD YES NO (50 Ω
spectrum analyzers only), EXT AMP YES NO , and TOTL PWR **IN** INPUT

The non-interfering RF and video measurement configuration softkeys include
GATING YES NO and PAUSE YES NO . These softkey functions apply to
channel measurement (CHANNEL **MEAS**) mode only.

The System **Beats** softkey is used to specify the channel you wish to
use for testing beats. The default measurement frequency for CTB is 6
MHz above the visual carrier; the default measurement frequency for CSO
is 4.75 MHz above the visual carrier. These values can be changed using
CT3 **FREQ** OFFSET and CSO **FREQ** OFFSET.

These settings are stored in nonvolatile analyzer memory. This means that
the analyzer retains the selections, even when power is turned off, until a
new selection is made. Press CABLE TV ANALYZER to access Setup

See Also

Descriptions for above mentioned softkeys in this chapter.
“Step 1. Configure the test system” in Chapter 2.

Softkey Descriptions

SOUND ON OFF Description

Allows you to turn the TV sound on and off. This feature is the same as the TV **RECEIVER** mode of operation except that it is accessed from a front-panel hardkey.

Press **AUX CTRL**, Monitor TV to access SOUND ON OFF .

See Also

“Step 5. Access the TV receiver mode” in Chapter 2.

STD Description

Allows you to select the standard (STD) channel tuning configuration.

If you do not select a channel configuration, the default configuration is the standard (STD) configuration. The choices for the channel tuning configuration are: standard (STD), off-the-air (AIR), incrementally related carriers (IRC), harmonically related carriers (HRC), and T format.

The analyzer retains the channel tuning configuration selection, even when power is turned off, until a new selection is made.

Press **CABLE TV ANALYZER** , Setup, Channel Tuning to access STD

See Also

“Step 1. Configure the test system” in Chapter 2.

SYS BTS TST CHNL Description

Allows you to select a channel to perform system beats testing. The default is channel 4.

If YES is selected after selecting Measure Now , system beats will be measured in the channel specified by SYS BTS TST CHNL . The results are displayed on the first page of the measurement data.

System beats testing is selected independently of the test plan and is not stored with the test plan. The analyzer retains the channel selection, even when power is turned off, until a new selection is made.

Pressing CABLE TV ANALYZER , Setup , System Beats accesses SYS BTS TST CHNL .

See Also

“Step 6. Make the measurements now” in Chapter 3.

System Beats Description

The System Beats softkey is used to specify the channel you wish to use for testing beats. The default channel is 4. The default measurement frequency for CTB is 6 MHz above the visual carrier; the default measurement frequency for CSO is 4.75 MHz above the visual carrier. These values can be changed using **CTB FREQ OFFSET** and **CSO FREQ OFFSET** .

These settings are stored in nonvolatile analyzer memory. This means that the analyzer retains the selections, even when power is turned off, until a new selection is made.

Press **CABLE TV ANALYZER, Setup** to access System Beats .

See Also

Descriptions for above mentioned softkeys in this chapter.
“Step 1. Configure the test system” in Chapter 3.

T Description

Allows you to select the T channel tuning configuration. As an alternative to making this selection, enter T channel numbers, 7 to 13, as negative numbers when any of the 4 other configurations are selected. If you do not select a channel tuning configuration, the default configuration is the standard (STD) configuration. The choices for the channel tuning configuration are: standard (STD), off-the-air (AIR), incrementally related carriers (IRC), harmonically related carriers (HRC), and T (upstream) format.

The channel tuning configuration selection is selected independently of the test plan and is not stored with the test plan. The analyzer retains the channel tuning configuration selection, even when power is turned off, until a new selection is made.

Press CABLE TV ANALYZER, Setup , Channel Tuning to access T

See Also

“Step 1. Configure the test system” in Chapter 3.

TOTL PWR @ INPUT Description

Allows you to measure the total power at the input of the analyzer. This function is primarily used automatically by tests to determine total input power to the analyzer so that the optimum input range for carrier-to-noise and CSO/CTB testing can be set to avoid analyzer internally generated inter-mods. Then, if using a filter during these tests, the analyzer automatically can increase its dynamic range.

This function can also be used in conjunction with an external preamplifier. By measuring the total input power, you ensure that the preamplifier's specifications are not exceeded, which could contribute to distortion products when measuring CSO/CTB.

Press CABLE TV ANALYZER , Setup, Analyzer Input to access
TOTL PWR @ INPUT

See Also

“Step 1. Configure the test system” in Chapter 2.

TV RECEIVER Description

Allows you to access the TV receiver mode. In this mode, you can view a TV picture and listen to the sound simultaneously by pressing CHANNEL SELECT , entering a TV channel number, then pressing PIX & SND ON OFF To exit this mode, press any softkey.

Press **MODE** to access TV RECEIVER

See Also

“Step 5. Access the TV receiver mode” in Chapter 2.

USR CH 0 CNTR FRQ Description

Allows you to define the center frequency for a user defined channel. This channel is then accessed by selecting channel 0 (zero). The setting defined here is stored in nonvolatile analyzer memory. This means that the analyzer retains the setting, even when power is turned off, until a new setting is made.

Press CABLE TV ANALYZER , Setup , Channel Tuning to access
CHNL 0 CNTR FRQ

See Also “Step 1. Configure the test system” in Chapter 2.

USR CH 0 SPAN Description

Allows you to define the span for a user defined channel. This channel is then accessed by selecting channel 0 (zero). The setting defined here is stored in nonvolatile analyzer memory. This means that the analyzer retains the setting, even when power is turned off, until a new setting is made. Press CABLE TV ANALYZER , Setup , Channel Tuning to access CHNL 0 SPAN

See Also “Step 1. Configure the test system” in Chapter 2.

Softkey Descriptions



Test Descriptions

Test Descriptions

What You'll Find in This Chapter

This chapter describes the cable TV tests found in the Channel and System modes of operation. The test descriptions are as follows:

- visual carrier level and visual-to-aural level difference test
- visual carrier frequency and visual-to-aural frequency difference test
- carrier-to-noise test
- composite second order (CSO) test
- composite triple beat (CTB) test
- hum test
- depth of modulation test
- digital channel power test
- color tests (chroma-luma delay inequality, differential gain, differential phase)
- in-channel frequency response test
- FM deviation test
- cross modulation test
- system frequency response test
- view ingress test
- view co-channel test

NOTE

The Cross Modulation, System Frequency Response, View Ingress, and View Co-Channel tests can only be done in Channel mode.

Visual Carrier Level and Visual-to-Aural Level Difference Test Description

The visual carrier level test measures the peaks of the visual carrier, as well as the visual-to-aural level difference.

To perform the visual carrier level and visual-to-aural level difference test, the analyzer does the following:

1. Changes the resolution bandwidth, video bandwidth, and sweep time of the analyzer to capture the levels accurately.
2. Measures the visual amplitude level and aural carrier difference.

Figure 8-1 shows the analyzer measuring the visual carrier level and aural carrier difference.

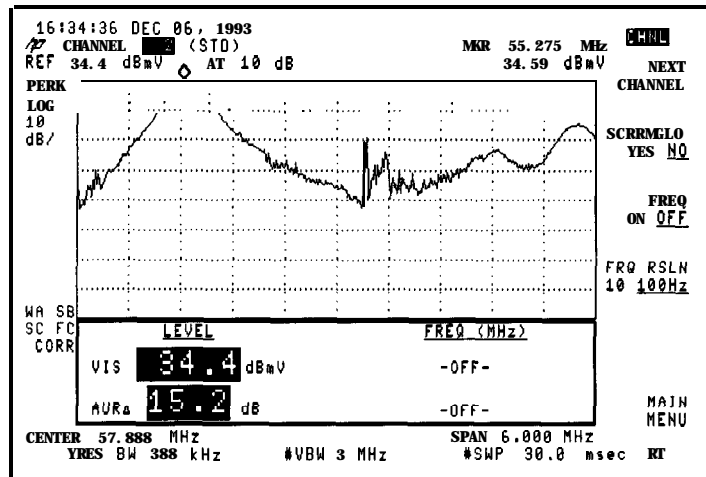

Figure 8-1. Measuring the Visual Level and Aural Carrier Difference

In channel measurement mode, the test runs continually and test results are updated after each test cycle (after each sweep).

Visual Carrier Level and **Visual-to-Aural** Level **Diff** erence Test Description

The aural carrier needs to be within 4.5 MHz (±0.4 MHz) of the visual carrier to be detected as the aural carrier. If the aural carrier cannot be detected, the visual-to-aural frequency difference measurement cannot be done and a “-” will appear in the system measurement test data for the channel.

The **SCRAMBLD** YES NO softkey, when set to YES, does a max hold function to catch and hold the values in non-suppressed sync tips.

Visual Carrier Frequency and Visual-to-Aural Frequency Difference Test Description

The visual carrier frequency test measures the frequency of the visual carrier, as well as the visual-to-aural frequency difference. In channel measurement mode, this test is executed by pressing the **FREQ ON** softkey after one cycle of a visual carrier level and visual-to-aural level difference test has been completed.

To perform the visual carrier frequency and visual-to-aural frequency difference test, the analyzer does the following:

1. Enables counting of the visual and aural carriers and calculates the aural carrier difference.
2. In channel measurement mode, the frequency counter resolution can be changed to 10 Hz without affecting measurement accuracy. Refer to the specifications in the HP 8591C Calibration Guide.

Figure 8-2 shows the analyzer measuring the visual and aural carriers.

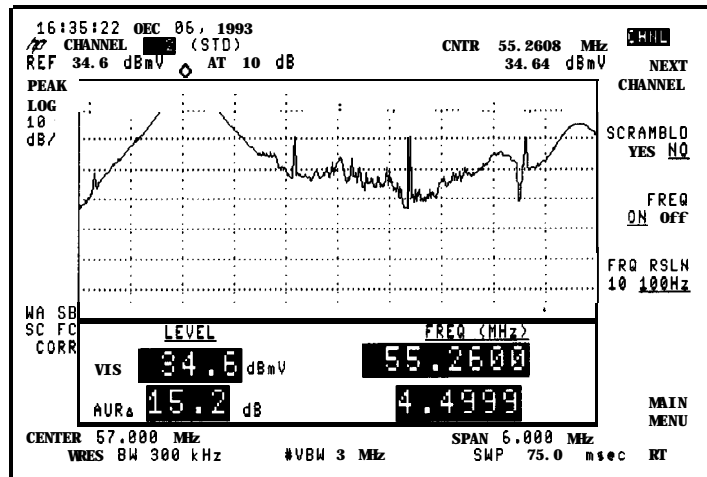

Figure 8-2. Measuring the Visual Frequency and Aural Frequency Difference

Visual Carrier Frequency and Visual-to-Aural Frequency Difference Test Description

The aural carrier needs to be within 4.5 MHz (± 0.4 MHz) of the visual carrier to be detected as the aural carrier. If the aural carrier cannot be detected, the visual-to-aural frequency difference measurement cannot be done and a “-” will appear in the system measurement test data for the channel.

Carrier-to-Noise Ratio Test Description

The result of the carrier-to-noise measurement is the ratio of the peak visual carrier level (modulated or unmodulated) to the noise measured in one of the manners described below. This ratio is normalized to a 4 MHz noise-power bandwidth.

There are three methods of measuring carrier-to-noise:

1. In-between channels.
2. Disable modulation and measure over FCC range.
3. Non-interfering (using Option 107) and measure over FCC range.

1. In-between channels

In the first method, the peak carrier level is measured first, then it continuously updates and reports the carrier-to-noise ratio for the marker position. The marker can be moved as desired and the result is updated to reflect the most current test result. At the end of each sweep, the marker does a local minimum search as well as a local trace average.

Before executing the test, the analyzer initially measures the total power of the entire cable system. This is done to set the attenuator to avoid overload of the input mixer and noise floor lift due to internally generated distortion.

The analyzer then measures its own noise figure and uses this for calculating the final carrier-to-noise value.

The analyzer input attenuation is set to both prevent input mixer compression and minimize the noise level of the analyzer.

Carrier-to-Noise Ratio Test Description

Initially, the marker is placed at the lower channel boundary. This provides an indication of the distribution system noise level without having to remove modulation. The minimum noise level is measured and compared with the noise level of the analyzer. If the difference between the minimum noise level and the noise floor is less than 10 dB, the minimum noise value cannot be measured directly, it is instead calculated by using the following formula:

$$\text{System noise} = 10\text{Log} [10^{DN} - 10^{AN}]$$

where

DN = displayed noise \div 10

AN = analyzer noise \div 10

To find the ratio of the visual carrier level to the noise level, the minimum noise level value is subtracted from the carrier peak level. The ratio is then normalized to a 4 MHz noise-power bandwidth.

The message See MORE INFO is displayed if the system noise is within 3 dB of the analyzer noise. This can be the case when carrier-to-noise is >50 dB and carrier levels are less than 20 dBmV. Refer to the graphs in the specifications located in the HP 8591C Calibration Guide.

NOTE

External preamplifier usage can be enhanced by entering amplifier gain and noise figure values in the **Setup** menu. By selecting an external preamplifier in the **Setup** menu, errors caused by the preamplifier can be accounted for in the carrier-to-noise calculation. When the internal preamplifier automatically turns on, its gain and noise figure are automatically accounted for and requires no operator attention.

Averaging minimizes the measurement-to-measurement variation of the system noise determination.

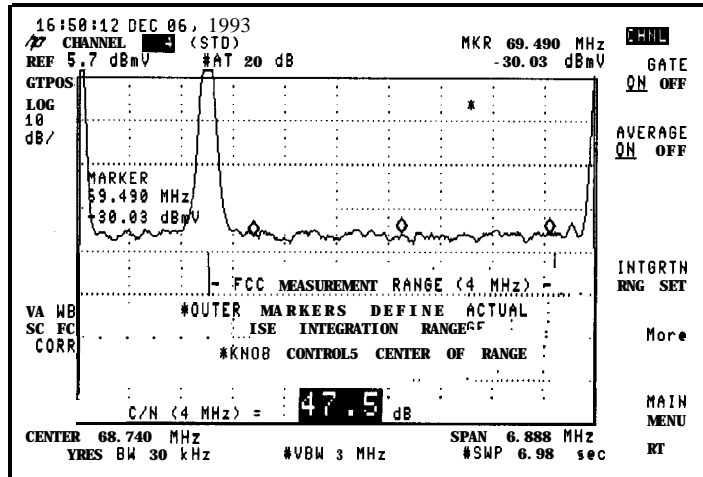

Figure 8-3. Carrier-to-Noise Measurement

In channel measurement mode, pressing More MORE INFO shows the raw data and all corrections used for this measurement.

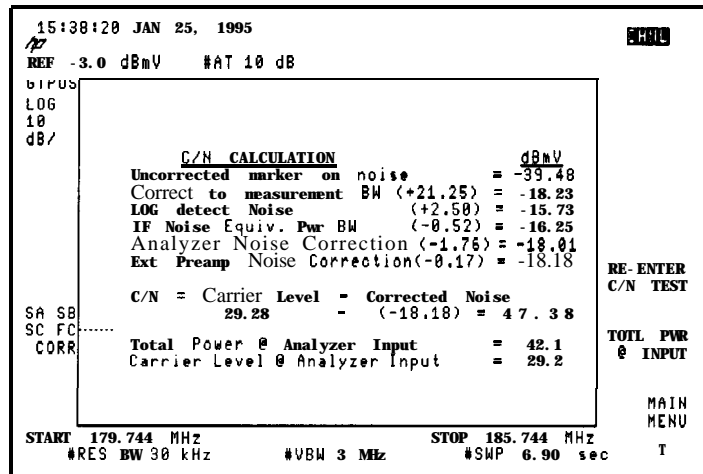

Figure 8-4. MORE INFO Screen

Carrier-to-Noise Ratio Test Description

2. **Disable modulation and measure over FCC range** The second method is an interfering measurement of carrier-to-noise in which modulation is removed. The marker is positioned within the displayed FCC measurement range. Averaging can be selected to stabilize the noise measurement.

Before returning to the main menu, the modulation must be turned back on

3. **Non-interfering (using Option 107) and measure over FCC range** The third method is called in-channel non-interfering carrier-to-noise measurements (Option 107 required) in which the gating function is used to make the measurement with video modulation on. This method is enabled with the GATE ON OFF key after the carrier-to-noise test has been started. A horizontal line with no test signals or data within the active line time is found (quiet line). Inchannel measurement mode, the CONTINUE softkey is then pressed to execute the measurement.

The analyzer displays the in-channel noise measured only during the quiet line. The minimum level noise is not found. Instead, noise can be measured over a range to account for possible non-flatness of the noise floor.

FCC 76.609(e) requires a noise integration be made over the full range if the noise floor is not flat. The outer markers in this test show the range over which the noise is integrated. Because of the presence of the visual carrier, integration over the full 4 MHz cannot be done. However, 85% of the entire range is integrated. See Figure 8-3.

The outer markers that are used to determine the range are set by pressing the INTGRTN **RNG SET** in channel measurements mode. Gated carrier-to-noise shows in-channel noise delivered in the video in addition to RF noise of amplifiers and headend equipment. Troubleshooting can be done without interrupting service. Advertisement insertion equipment may yield different results when active.

**More Discussion about
the Carrier-to-Noise
Test**

The carrier-to-noise test is very flexible and can handle a wide variety of testing conditions. It provides feedback messages to assist you in achieving the optimum test setup.

Like any cable TV active device, a spectrum analyzer has an ideal operating point which balances carrier-to-noise and carrier beats. When a spectrum analyzer is operating at its optimum point it has its greatest testing dynamic range. However, to achieve acceptable results it is not always necessary to operate the spectrum analyzer exactly at its optimum point. To achieve acceptable results only 2 conditions are needed:

1. The total power at the analyzer input is below overloading the analyzer.
2. The noise floor being measured is equal to or greater than the noise floor of the analyzer.

Channel loading forces down the highest acceptable level of each individual channel carrier which gives rise to the need to preselect the channel of interest. This is necessary when the noise floor being measured is less than the analyzer noise floor when the total input power is near overload. The only way to raise the noise floor without overloading the analyzer is to reduce channel loading through preselection.

When CARRIER/NOISE is pressed the analyzer measures the total power at the input, the level of the channel to be measured, and the analyzer noise floor. Based on this information it decides whether to turn on the internal preamp, and what the analyzer attenuator setting should be. In addition, it alerts you when it thinks additional attention is needed. This is indicated by the presence of message (See MORE INFO) in the lower right hand corner of the screen. This message occurs when the cable noise floor is within 3 dB or the analyzer noise floor. It is intended to alert the operator that the analyzer noise-near-noise correction is kicking in. In addition, the message is presented in inverse video when the cable noise floor is within 2.2 dB of the analyzer noise. This indicates the analyzer is correcting the result by more than 3 dB and measurement uncertainty of the result is rising. It is intended that you raise the input level and preselect if necessary.

Carrier-to-Noise Ratio Test Description**More about the MORE INFO Screen**

The MORE INFO screen is intended to explain how the carrier-to-noise result is calculated and to assist you in making sure this result reflects the actual carrier-to-noise on the signal being measured. To assist you in adjusting the input level, the MORE INFO screen has several messages instructing you to raise or lower the input level and try the test again. In addition, when conditions warrant it, other message prompts suggesting preselection or other actions can appear on this screen. These messages only occur when the analyzer noise-near-noise correction is correcting more than 3 dB. The messages are as follows:

Raise Input Level x to y dB:

This message appears when there is a need to raise the cable noise level and more input power can be tolerated without overload.

or Reduce Input Level x to y dB:

This message may appear as an alternative to raising the input level. It appears when it may be possible to reduce the input power a small amount but just enough to cause the analyzer to switch its internal 10 dB attenuator down by 1 step. This has the effect of raising the input level by 10 dB less the number of dB the input level was reduced by. Try this when raising the level is inconvenient or impossible for some reason. Alternatively, when this message appears it signals that it may be possible to not change the level at all, but to re-run the test and reduce the attenuator manually using the ATTEN keys on the 2nd C/N menu.

Preselect Input Signal:

This message appears when there is no longer any headroom to raise the level before overload occurs, but there is still need to raise the cable noise level and there is significant channel loading present.

Raise level 10 dB, re-enter test, turn carrier off, reduce attenuator:

This message appears when a preselected signal requires increased noise level but the single carrier present will overload the analyzer. This message suggests that you raise the input level above overload, let the analyzer measure the carrier level, then turn the carrier off to eliminate the overload while noise is being measured.

More about the MORE INFO Screen (continued)**Try raising level even more.:**

This message assumes the technique mentioned just above was followed but even more dynamic range is desired. It suggests following the above technique but raising the level 20, 30, or more dB

Try reducing the internal attenuator.:

This message appears instead of the message just above when the attenuator is >0 dB.

The messages above are the analyzer best guess as to what to do given the conditions it can determine. They are not foolproof and are intended to be taken as suggestions only, not concrete rules for what to do.

Once the optimum input power level is achieved, it does not need to be readjusted for each channel. All channels can be measured without further adjustments to the input level.

The internal preamp is controlled automatically. It is only turned on at levels low enough to prevent overload. Under some conditions the internal attenuator is set to 10 dB to prevent preamplifier overload. When the internal preamplifier is turned on, a message to that effect is displayed at the lower right hand corner of the screen.

The carrier-to-noise test has 2 variations. The first is the traditional method where the video modulation is either left on and the noise is measured at the lower channel boundary, or the video modulation is turned off and the noise is measured in the frequency range specified by the FCC. The second variation is measuring the noise during the vertical interval on a single horizontal line that has no modulation. This is referred to as a “quiet line”. The analyzer defaults to line 12, but any quiet line can be used. Line 12 is quiet on most channels.

Measuring noise on a quiet line is called a “gated” measurement. That is, the analyzer gates its frequency domain measurement during a specific time slot; that slot being during the selected quiet line. Option 107 is required to make this measurement.

Carrier-to-Noise Ratio Test Description

Pressing CARRIER/NOISE can have different results depending on 2 keys in the setup menu, GATING YES/NO and PAUSE YES/NO . GATING set to NO and PAUSE set to YES are the best settings for initially becoming familiar with carrier-to-noise test. GATING set to NO causes the carrier- to-noise test to initially enter the first variation of the test as described above. At this point you can observe the noise at the lower channel boundary. If there is a composite second order product at the lower channel boundary, the marker will move slightly above it. This noise value is the system noise from the output of the headend to the point of measurement. It does not include noise contributed by headend active components or converters. Thus noise measured the lower channel boundary must be added to the noise contributions of headend components and converters (if used).

To move from the non-gated to the gated test, press CONTINUE. Now, depending on the setting of PAUSE (and option 107 being present) the test will either stop with line 12 displayed, or move directly into the gated C/N test. When PAUSE is set to YES, line 12 is displayed giving you the opportunity to explore the vertical interval by changing the line and field values. A different line from 12 can be selected. If PAUSE is set to NO, this step is skipped unless the analyzer finds it cannot recognize a quiet line. It begins looking for a quiet line on line 12, but if it finds line 12 to be not quiet, it moves to line 10, searches both fields there and moves up through the lines to 20 looking for a quiet line. Thus, when PAUSE is NO, it will still pause if it cannot find a quiet line.

When GATING is set to YES, pressing CARRIER/NOISE results in bypassing of variation 1. Then, if PAUSE is set to NO, the analyzer will move directly to the gated test. It is intended that you will select this configuration of GATING and PAUSE after becoming familiar with the operation of the test.

Another difference between the non-gated and the gated variations of the test is the frequency range over which the noise is measured. The non-gated test measures the noise at the current marker position averaged with 1 position on either side. In a 6 MHz span, 3 measurement buckets is a range of 45 kHz. This range is then mathematically converted to the 4 MHz reporting bandwidth. This assumes the noise floor is flat which is almost always true when using the method of turning modulation off to make the measurement. The gated measurement has the added flexibility of being able to measure over a much wider frequency range. This is necessary when measuring with a video signal present because the noise floor is very often not flat. Therefore measuring at a single point and converting to a 4 MHz bandwidth can give incorrect results. The FCC rules stipulate that when the noise floor is not flat that it must be integrated or summed. The gated carrier-to-noise test integrates over as wide a range as it can. It defaults to 85% of the 4 MHz range. It cannot be 100% because the carrier is always present and cannot be gated away. However, the noise below the carrier is almost always equal to or less than the noise in the rest of the channel so it is conservative to assume the integrated value also applies to the noise under the carrier. You can change the range of 85 % . Entering 1% replicates the non-gated noise measurement range.

Refer to “Carrier-to-noise test” in Chapter 2 for information on how to make a measurement.

Composite Second Order (CSO) Test Description

Three methods of measuring CSO are described here:

- channel CSO
- CSO using gating function
- system CSO

The analyzer measures the total cable TV system power and adjusts its input attenuation for optimum performance (refer to the graphs in Chapter 9).

Distortion near noise corrections are used to more accurately measure distortion products less than 10 dB above the analyzer noise.

1. Channel CSD

The composite second order (CSO) test measures the relative level of second order inter-modulation products that are offset from the carrier under test by ± 750 kHz or ± 1.25 MHz.

The CSO beat at -1.25 MHz falls on the lower channel boundary and can be measured without turning the channel off. This beat only appears on lower channel numbers.

The trace is a time averaged display appropriate for measuring beats. The marker does a local peak search to assure it is measuring the peak of the beat.

2. CSD using **gating** function

With the Option 107 installed, the carrier modulation does not have to be turned off. After initiating the CSO/CTB test and after the gate function has been selected with the GATE ON OFF key, a quiet line (horizontal line without modulation) is selected. The CONTINUE softkey is then pressed to perform the measurement. The analyzer displays the in-channel noise and CSO beats measured only during the quiet line. In this way, measurements can be made without interrupting service.

A special case occurs for channels 5 and 6 in a standard channel plan. These channels are placed 4 MHz above where they would be if they followed the normal placement (as in IRC). This allows for measurement of CTB on these channels with the gating function.

Refer to “Composite Second Order/Composite Triple Beat Test” in Chapter 2.

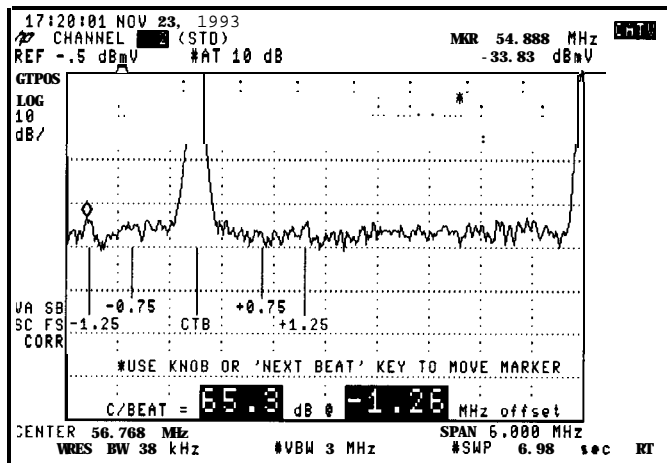

Figure 8-5. Determining the level of the Beat Product and Noise Level

3. System CSO

This test is performed on the channel specified using the SYS BTS TST CHML softkey in the Setup menu. This applies to the system measurements mode.

The system CSO test measures the beat product at an offset from the test channel set by CSO **FREQ OFFSET**. The default for CSO **FREQ OFFSET** is 4.75 MHz. This can be set to +7.25 when measuring higher channel numbers. Figure 8-5 shows the analyzer measuring the level of the beat product and noise level for CSO beat products.

With this method of measuring CSO, a preamplifier is not generally needed for accurate testing.

Composite Triple Beat (CTB) Test Description

Two methods of measuring CTB are described here:

- channel CTB
- system CTB

The analyzer measures the total cable TV system power and adjusts its input attenuation for optimum performance (refer to the graphs in Chapter 9).

Distortion near noise corrections are used to more accurately measure distortion products less than 10 dB above the analyzer noise.

1. Channel CTB

The CTB beat appears directly under the visual carrier. Therefore, turning the carrier off during the channel CSO/CTB test is the only method of testing the CTB of each channel.

The marker does a local peak search to assure it is measuring the peak of the beat.

2. System CTB

The composite triple beat (CTB) test measures the relative level of third order inter-modulation products that align in frequency with the carrier under test. System CTB testing is intended to be performed on only one channel and is performed at an offset from the channel specified using the SYS BTS TST CHNL softkey in the Setup menu. The offset is specified by CTB **FREQ OFFSET** ; the default value is 6 MHz.

Setting CTB **FREQ OFFSET** to -6 MHz will allow testing 6 MHz below the beats test channels. The default location for measuring beats with the analyzer is in the unused frequency band between channels 4 and 5.

In system measurement mode, the analyzer first measures the peak level of the test channel (channel 4), and then measures any composite triple beat products in the frequency gap between channels 4 and 5. *If there is a signal within ± 200 kHz of the CTB test channel, the CTB results will be inaccurate.* If you are broadcasting a signal between channels 4 and 5, you must either turn off the signal or change the frequency at which CTB is tested.

The CTB measurement is done as follows:

1. The visual carrier peak level of the test channel (default is channel 4) is measured.
2. Control line B of the analyzer auxiliary interface is set to a TTL-high level.
3. The center frequency of the analyzer is increased to the frequency of the test channel plus the CTB offset of 6 MHz (default setting of CTB **FREQ** OFFSET).
4. The beat level is measured
5. The beat level is subtracted from the visual carrier peak level.
6. Control line B of the analyzer auxiliary interface is set to 0 volts dc.

The visual carrier peak level of the test channel is measured

To End the beat products, the analyzer center frequency is changed so that any beat products in the gap between channels 4 and 5 can be measured. To avoid measuring the skirts of the visual carrier, the resolution bandwidth and frequency span of the analyzer are decreased. To optimize the distortion measurement capability of the analyzers, the reference level is decreased to bring the noise level within the first six divisions of the graticule, and input attenuation is adjusted for the best dynamic range.

At this point in the CTB test, the control B line of the analyzer auxiliary interface is set to a TTL high level. If you wish to momentarily turn off the carrier, you may find it useful to use control line B (with additional circuitry) to turn off the carrier.

The beat level is measured

To accurately determine beat amplitude, the beat level is measured and compared with the level of the analyzer noise. If the difference between the beat level and the analyzer noise is less than 10 dB, the beat value cannot be measured directly; it is instead calculated by using the formula:

$$\text{Beat Level} = 10\text{Log} [10^{BP} - 10^{NL}]$$

where

BP = Beat product \div 10

NL = Analyzer noise level \div 10

With this method of measuring CTB, a preamplifier is not generally needed for accurate testing.

The beat level is subtracted from the visual carrier peak level

To find the value for CTB, the beat level is subtracted from the visual carrier peak level.

More Discussion about the CSO/CTB Tests

The carrier-to-beats test is very flexible and can handle a wide variety of testing conditions. It provides feedback messages to assist you in achieving the optimum test setup.

Like any cable TV active device, a spectrum analyzer has an ideal operating point which balances C/N and C/Beats. When a spectrum analyzer is operating at its optimum point it has its greatest testing dynamic range. However, to achieve acceptable results it is not always necessary to operate the spectrum analyzer exactly at its optimum point. To achieve acceptable results only 2 conditions are needed:

1. The total power at the analyzer input is below overloading the analyzer.
2. The beat being measured is equal to or greater than 3 dB above the noise floor of the analyzer.

Channel loading forces down the highest acceptable level of each individual channel carrier which gives rise to the need to preselect the channel of interest. This is necessary when the cable system noise floor is less than the analyzer noise floor when the total input power is near overload. The only way to raise the noise floor without overloading the analyzer is to reduce channel loading through preselection.

When **CS0/CTB** is pressed the analyzer measures the total power at the input, the level of the channel to be measured, and the analyzer noise floor. Based on this information it decides what the analyzer attenuator should be set to. In addition it alerts you when it thinks additional attention is needed. This is indicated by the presence of message (See MORE INFO) in the lower right hand corner of the screen. This message occurs when the cable noise floor is within 3 dB of the analyzer noise floor. It is intended to alert the operator that the analyzer signal-near-noise correction is kicking in. In addition, the message is presented in inverse video when the cable noise floor is within 2.2 dB of the analyzer noise. This indicates the analyzer is correcting the result by more than 3 dB and the measurement uncertainty of the result is rising. It is intended that you raise the input level and preselect if necessary.

Composite Triple Beat (CTB) Test Description

More about the MORE INFO Screen

The MORE INFO screen is intended to explain how the CSO/CTB result is calculated and to assist you in making sure this result reflects the actual beat level on the signal being measured. To assist you in adjusting the input level, the MORE INFO screen has several messages instructing you to raise or lower the input level and try the test again. In addition, when conditions warrant it, other message prompts suggesting preselection or other actions can appear on this screen. These messages only occur when the analyzer signal-near-noise correction is correcting more than 3 dB. The messages are as follows:

Raise Input Level x to y dB:

This message appears when there is a need to raise the cable noise level and more input power can be tolerated without overload.

or Reduce Input Level x to y dB:

This message may appear as an alternative to raising the input level. It appears when it may be possible to reduce the input power a small amount but just enough to cause the analyzer to switch its internal 10 dB attenuator down by 1 step. This has the effect of raising the input level by 10 dB less the number of dB the input level was reduced by. Try this when raising the level is inconvenient or impossible for some reason. Alternatively, when this message appears it signals that it may be possible to not change the level at all, but to re-run the test and reduce the attenuator manually using the ATTN keys on the 2nd C/N menu.

Preselect Input Signal:

This message appears when there is no longer any headroom to raise the level before overload occurs, but there is still need to raise the cable noise level and there is significant channel loading present.

The messages above are the analyzer best guess as to what to do given the conditions it can determine. They are not foolproof and are intended to be taken as suggestions only, not concrete rules for what to do.

Once the optimum input power level is achieved, it does not need to be readjusted for each channel. All channels can be measured without further adjustments to the input level.

The CSO/CTB test has 2 variations. The first is the traditional method where the video modulation is either left on and the -1.25 MHz CSO beat is measured at the lower channel boundary, or the carrier is turned off and the CTB & CSO beats are measured. The second variation is measuring the CSO beats during the vertical interval on a single horizontal line that has no modulation. This is referred to as a “quiet line”. The analyzer defaults to line 12, but any quiet line can be used. Line 12 is quiet on most channels.

Measuring CSO beats on a quiet line is called a “gated” measurement. That is, the analyzer gates its frequency domain measurement during a specific time slot; that slot being during the selected quiet line. Note that Option 107 is required to make this measurement.

Pressing **CSO/CTB** can have different results depending on 2 keys in the setup menu, the GATING YES/NO and the PAUSE YES/NO keys. GATING set to NO and PAUSE set to YES are the best settings for initially becoming familiar with carrier-to-beats test. GATING set to NO causes the carrier-to-beats test to initially enter the first variation of the test as described above. At this point you can observe the -1.25 MHz beat at the lower channel boundary.

To move from the non-gated to the gated test, press CONTINUE Now, depending on the setting of PAUSE (and option 107 being present) the test will either stop with line 12 displayed, or move directly into the gated carrier-to-noise test. When PAUSE is set to YES, line 12 is displayed giving you the opportunity to explore the vertical interval by changing the line and Eeld values. A different line from 12 can be selected. If PAUSE is set to NO, this step is skipped unless the analyzer finds it cannot recognize a quiet line. It begins looking for a quiet line on line 12, but if it finds line 12 to be not quiet, it moves to line 10, searches both Eelds there and moves up through the lines to 20 looking for a quiet line. Therefore, when PAUSE is NO, it will still pause if it cannot find a quiet line.

When GATING is set to YES, pressing **CSO/CTB** results in bypassing of variation 1. Then, if PAUSE is set to NO, the analyzer will move directly to the gated test. It is intended that you will select this configuration of GATING and PAUSE after becoming familiar with the operation of the test.

Hum Test Description

The hum test measures the percentage of amplitude modulation for low frequency disturbances (hum) by measuring the peak-to-peak variation for total hum. The Fast Fourier Transform (FFT) is also used to display the low frequency spectrum around the carrier. This information can be used to identify the source of hum.

Total hum is measured by reading the peak-to-peak variation in the visual signal level caused by low frequency disturbances (hum or repetitive transients).

The hum test automatically configures the analyzer for measuring with or without video modulation on the carrier. This is necessary because analyzer settings used to match the *NCTA Recommended Practices* cannot be used when video modulation is present. Other analyzer settings can be used to compensate for the presence of video modulation, then the measurement can be made.

When video modulation is on, the video bandwidth is set to 1 MHz to allow the analyzer to measure only the values of the sync tips. See Figure 8-6. When the video bandwidth is set to 1 MHz, significant noise is also present. This noise is digitally minimized, then several peak-to-peak measurements are taken and averaged. Using the average of these measurements gives the best consistency with visual oscilloscope measurements. However, the effects of noise cannot be completely eliminated and the results reported have slightly more uncertainty (usually less than 1 percent larger) than when video modulation is off. The reverse, however, is not true. That is, when adding modulation to a carrier wave signal, results will increase, not decrease. For example, if the results are less than 3 percent with modulation on, FCC rule 76.605(a)(10) is satisfied. If a channel does exceed 3 percent, it may still pass by testing again without video modulation.

When video modulation is not present, the test sets the analyzer to the conditions set forth in the *NCTA Recommended Practices*. See Figure 8-7. A setting of zero span with a sweep time of 5 ms/div acts as a signal level meter and oscilloscope display, and a video bandwidth of 1 kHz functions as a 1 kHz low pass filter. Several peak-to-peak measurements are taken, then the average measurement is reported.

Selecting the MORE INFO softkey displays the low frequency spectrum around the visual carrier. The marker can be used to identify the frequency and level of interference relative to the carrier. Obtaining meaningful results even in the presence of video modulation is a great benefit. No one needs to be present at the headend to temporarily insert a carrier wave signal, and subscribers are not deprived of service. On a properly operating system, results with video modulation present will usually be under the 3 percent limit. Low frequency disturbances on channels above the limit are often a combination of video field time distortion on the received signal and cable system hum. The dominant contributor may be identified by removing the signal input to the headend, inserting a clean carrier wave signal on that input, and retesting.

More than 3 percent field time distortion on off-air signals has been observed, but it also has been seen to be caused by multi-path interference between the transmitter and the headend antenna. Field time distortion on the signal can also be qualitatively separated from cable hum by observing whether the distortions vary with time or picture level since cable hum won't change with picture level.

Test Descriptions
Hum Test Description

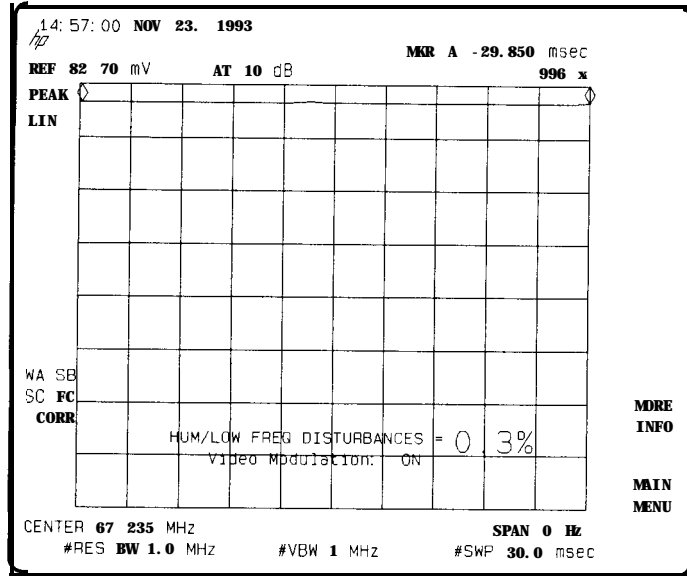

Figure 8-6. HUM, Video Modulation On

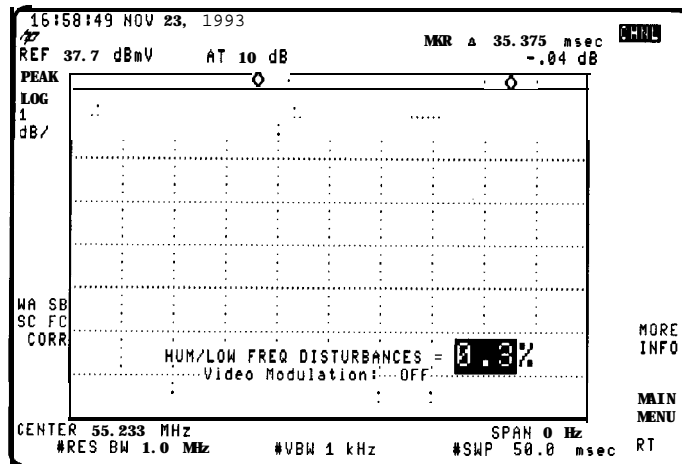

Figure 8-7. HUM, Video Modulation OFF

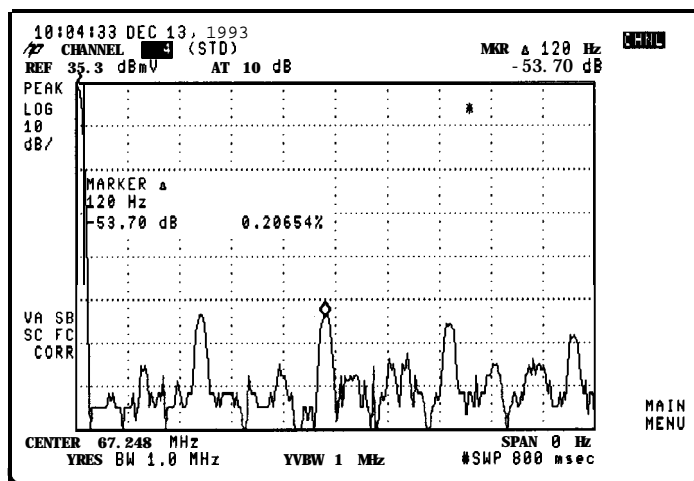

Figure 8-8. HUM, More Information

Depth of Modulation Test Description

The depth of modulation test measures the percentage (50 to 93 percent measurement range) of amplitude modulation (AM) on the visual carrier. The analyzer measures the horizontal synchronization-pulse level and vertical interval test signal (VITS) white level from which it calculates the percentage of AM.

Scrambled Channels

The visual carrier AM modulation depth test may not be valid for scrambled channels, depending on the method used to scramble the channel's signal. So, when testing a scrambled channel, You may want to momentarily turn off scrambling for the channel while the channel is being tested for AM modulation depth. You can use control line A of the analyzer auxiliary interface to determine when the analyzer is testing a scrambled channel. When testing a scrambled channel, the control A line (pin 1) of the analyzer auxiliary interface is set high in transistor-to-transistor logic (TTL).

To perform the depth of modulation measurement, the analyzer does the following:

1. Changes the center frequency and reference level of the analyzer.
2. Changes the amplitude scale and span of the analyzer.
3. Measures the minimum level and the maximum level and calculates the percentage of AM modulation depth.

Changes the center frequency and reference level of the analyzer

The visual carrier is centered on the analyzer screen and a 1 MHz resolution bandwidth is used to capture the entire modulation signal. For better accuracy, the reference level of the analyzer is changed to the level of the visual carrier.

Changes the amplitude scale and span of the analyzer

The amplitude scale is changed from logarithmic (dB) to linear (volts) and the span is set to 0 Hertz to demodulate the signal and display time domain characteristics.

Measures the minimum level and the maximum level and calculates the percentage of AM modulation depth

The analyzer measures the minimum level and the maximum level. The minimum level corresponds to the vertical interval test signal (VITS) white level and the maximum level corresponds to the horizontal synchronization-pulse (H-sync) level. The ratio of the minimum level (the VITS white level) to the maximum level (the H-sync pulse level) subtracted from a value of 1 and multiplied by 100 gives the percentage of modulation:

$$\left[1 - \frac{\text{minimum}}{\text{maximum}} \right] \times 100 = \%AM$$

Figure 2-27 shows the analyzer measuring the minimum and maximum levels.

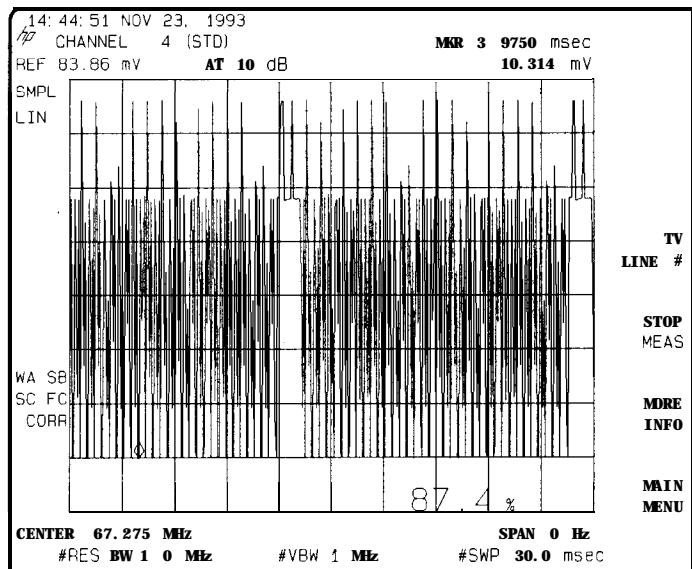

Figure 8-9. Measuring the Depth of Modulation

The depth of modulation result is displayed at the bottom of the screen.

Digital Channel Power Measurement Description

The digital channel power measurement computes the total power within the specified bandwidth (between markers) of the selected channel. The result is recomputed after each sweep (if averaging is off) and displayed in current measurement units. With averaging on, the result is displayed after the number of specified sweeps has been reached.

The user must first tune to the desired channel before executing the test. The channel edges must reside within the display limits, and occupy at least 75% of the selected span for best results. The reference level should also be set so that the peak of the signal falls approximately 10 to 20 dB below the top of the display. Refer to the digital channel power test description, in the channel measurement section, for operating instructions.

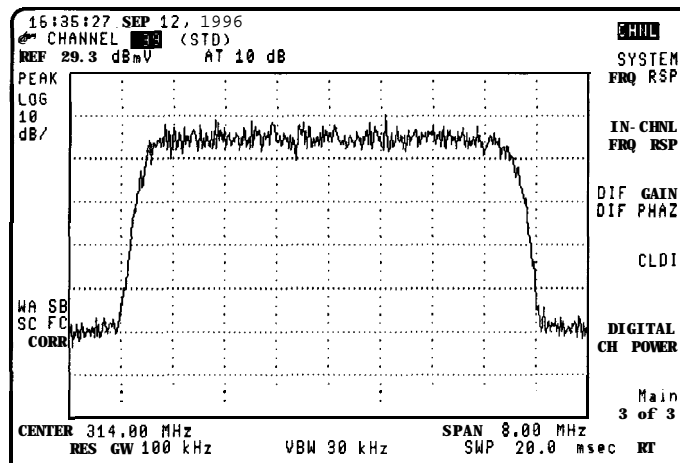

Figure E-10. Tuned Digital Channel Display

The test automatically locates the estimated left and right edges of the channel using the marker minimum peak function. If the automatic marker placement is not ideal, the markers may be repositioned by the user.

The resolution and video bandwidth settings are automatically set according to the frequency span setting when the test is entered.

We assume that the channel BW is at least 75% of the selected frequency span.

Table 8-1.
 Auto Resolution Bandwidth (RBW) and Video Bandwidth (VBW) selection

Freq Span	RBW(kHz)	VBW(kHz)
SPAN \geq 12 MHz	300	3000
12 MHz > SPAN \geq 4 MHz	100	1000
4 MHz > SPAN \geq 1.2 MHz	30	300
1.2 MHz > SPAN \geq 0.4 MHz	10	100
SPAN < 0.4 MHz	3	30

Please note the analyzer has been configured for maximum accuracy. Adjustment of VBW or RBW may degrade measurement performance.

The following steps are performed to determine channel power:

The logarithmic trace is converted to linear units (volts) and the RMS average is computed. The value is then converted back to logarithmic measurement units.

The power result is then normalized to a power spectral density in a 1 Hz bandwidth and scaled to the desired channel bandwidth.

The formula is:

Channel power = (Noise equivalent BW) x (RMS power spectral density in a 1 Hz BW)

Where:

Noise equivalent BW = IBW / 1.128 x RBW

Power spectral density in a 1 Hz BW = total power / total BW

IBW = Channel BW or integration BW

RBW = Resolution bandwidth

Digital Channel Power Measurement Description

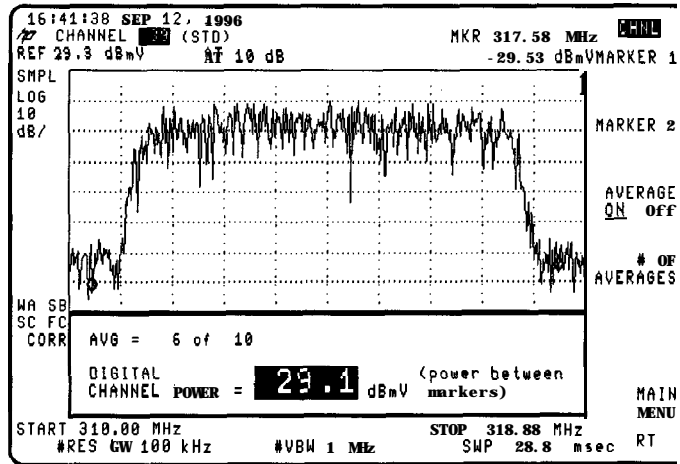

Figure E-11. Results of Digital Channel Power Test

Color Test Descriptions (Chroma/Luma Delay Inequality, Differential Gain, Differential Phase)

The color tests measure the chrominance-to-luminance delay inequality, differential gain, and differential phase (Option 107 required).

The following steps must be considered when performing these measurements:

1. An appropriate test signal must be present or the test will not return meaningful results. Refer to Figure 8-12 and Figure 8-13.
2. Multiple test signals may be present and may return different results due to their point of origin.
3. Commercial insertion equipment may cause test signals to not be transmitted.

If this occurs during a test, the results will not be valid.

4. Visual signal levels greater than +20 dBmV will provide best results.
5. Non-standard timing in signal composition may not yield specified accuracy.
6. Large amounts of non-linear distortion, group delay, or ghosting may yield results different from other test methods.

Surveying your system for test signal types and locations for each channel will simplify test plan generation. Blank charts are located in Appendix A. Copy these charts and fill in appropriate information using channel measurement mode.

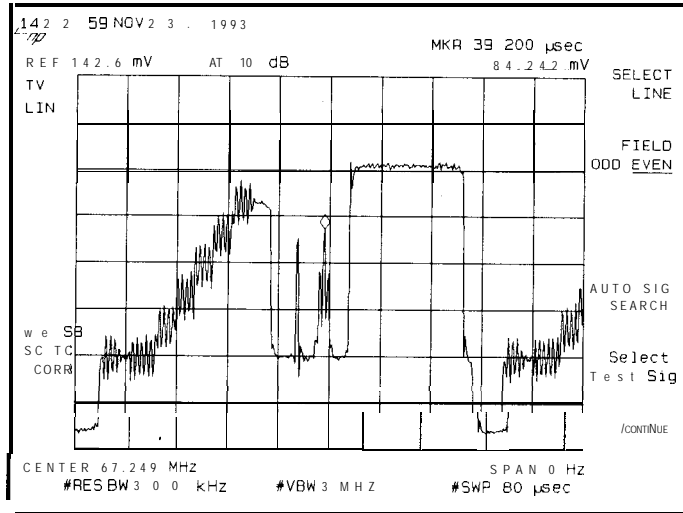

Figure 8-12. FCC Composite Test Signal

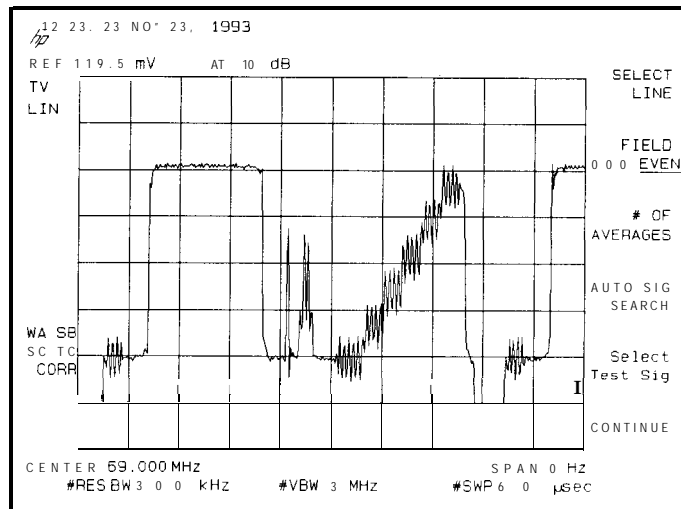

Figure 8-13. NTC 7 Composite Test Signal

Chroma/Luma Delay Inequality Test Description

NOTE

The analyzer internal frequency calibration routine should be done at the temperature the test will be performed for best accuracy

Non-standard timing between the 2T and 12.5T pulses will return values that are offset by up to 25 ns. The “T” in NTSC systems is 125 ns. A 2T pulse has a half amplitude duration of 250 ns for NTSC; 12.5T pulse has a half amplitude duration of 1.5625 μ s.

The chroma/luma delay inequality test measures the time delay between the low frequency luminance component and the high frequency chrominance component of the 12.5T modulated pulse in the composite test signal. Refer to Figure 8-14.

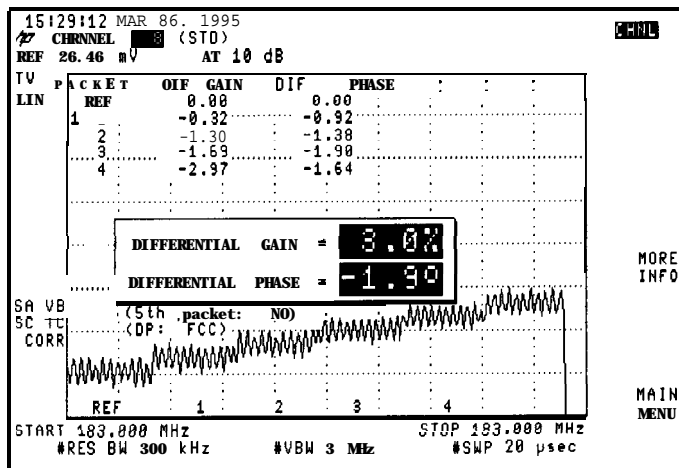

Figure g-14. Chrominance-to-Luminance Delay

The composite test signal (FCC, NTC 7) is automatically selected. The analyzer then tunes to the luminance component and switches to 0 Hz span. Video averaging is performed and the center of the luminance component is found and converted to time.

Next, the analyzer tunes to the chrominance component and performs video averaging. The center of the chrominance component is found and converted to time. The time difference between the two components is then computed.

Since the analyzer measures absolute time, an offset of 170 ns is added to the result so that it will agree with tests done using a demodulator with sound trap in (170 ns of delay,) and the result will be shown relative to the FCC required pre-correction. See Table 8-2.

Table 8-2. Comparison of **CLDI** Measurement Values

Relative to FCC Required Pre-Correction	-170	0	+170
Absolute	-340	-170	0

Differential Gain Test
Description

The differential gain test measures the change in amplitude of the chrominance subcarrier as the luminance changes from a blanking level towards white level. The five-step riser portion of the test signal is used to perform this measurement. The test signal is automatically selected.

A fast fourier transform is performed on the reference burst and each step in the five-step riser. Each step is normalized to the reference burst. Averaging is employed to minimize noise contribution to the reading.

The peak-to-peak amplitude of the largest riser step is found. Then, the riser step with the smallest peak-to-peak amplitude is found. The difference between the two amplitudes is computed and expressed as a percentage of the largest amplitude. Differential gain calculation where max = largest packet value in % and min = smallest packet value in % follows:

$$\left[\frac{(max + 100) - (min + 100)}{max + 100} \right] \times 100 = DG$$

If 5th PKT YES NO is set NO, then the calculation is based on the first four steps in the five-step riser in channel measurement mode. The 5th packet is always used in system measurement mode. The MORE INFO softkey shows the normalized values of each packet. This is useful for relative measurements.

Differential Phase Test Description The differential phase test measures the change in phase of the chrominance subcarrier as the luminance changes from a blanking level towards white level.

The five-step riser portion of the test signal is used to perform this measurement. The test signal is selected automatically.

Again a Fast Fourier transform is performed on the reference burst and each step in the five-step riser. Each step is normalized to the reference burst. The differential phase test can be configured for each of the two common definitions for this test. For the NTC definition, the largest phase difference between any two riser steps (including the reference) is calculated and displayed. For the FCC (NCTA) definition, the largest phase difference between the reference and any riser step is calculated and displayed.

If 5th PKT YES NO is set to NO, then the calculation is based on the first four steps in the five-step riser in channel measurement mode. The 5th packet is never used in system measurement mode. MORE INFO shows the normalized values for each packet. This is useful for relative measurements. See Figure 8-15.

The FCC differential phase is equal to the largest packet value in degrees from the phase of the reference packet.

The NTC differential phase calculation is as follows: (where max = largest packet value in degrees and min = smallest packet value in degrees)

$$DP = \mathit{max} - \mathit{min}$$

Color Test Descriptions (Chroma/Luma Delay Inequality, Differential Gain, Differential Phase)

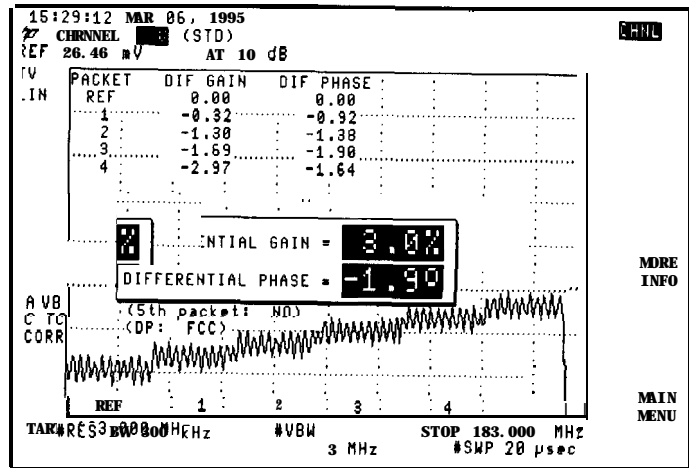

Figure g-15. Differential Gain/Differential Phase

In-Channel Frequency Response Test Description

The in-channel frequency response test sets the analyzer to view full-field test signals such as multi-burst, sinX/X, or line sweep. In addition, it can view an in-channel sweep signal. The sweep signal can either be continuously or manually swept. Figure 8-16 is the result of manually sweeping a signal generator across the measurement range.

Multi-burst is a popular signal but it has some limitations. Figure 8-17 shows full-field FCC multi-burst.

Note that the 0.5 MHz burst packet cannot be resolved in a resolution bandwidth of 300 kHz. However, 300 kHz is the minimum bandwidth required for the analyzer to accurately measure burst packets greater than 4.25 μ s.

If all the burst packets were the same time duration, a resolution bandwidth of 100 kHz could be used. The burst height would not be accurate but they all have the same relative amplitude.

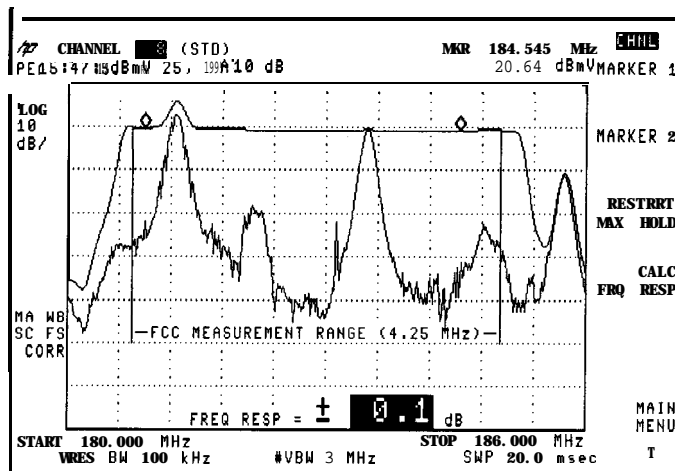

Figure E-16. In-Channel Frequency Response

In-Channel Frequency Response Test Description

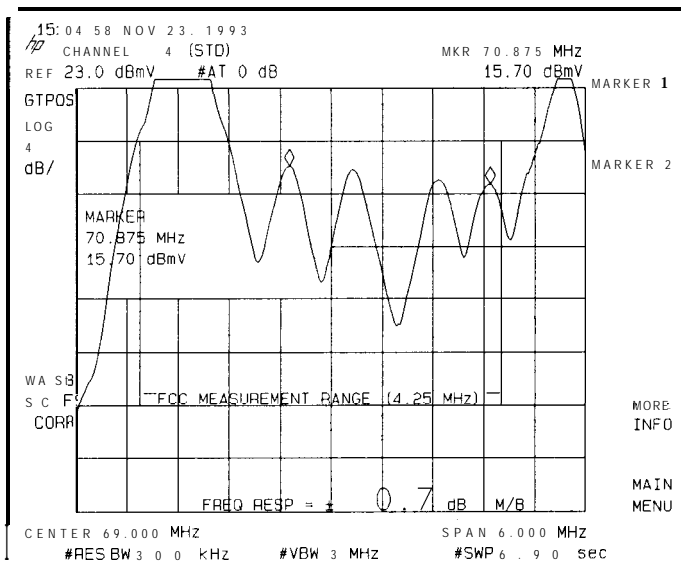

Figure g-17. Multi-Burst Response

Single line VITS Testing Single line vits testing can be performed on multiburst, sin X/X, Philips ghost canceling reference (GCR), or NTC-7 combination.

GCR provides the best results because it has the most signal level and it is a swept frequency over the range of interest.

The sin X/X is also a continuous signal in the frequency domain when using 100 kHz resolution bandwidth for detection. Its lower energy content requires higher signal levels or averaging to be used to get equivalent results to the GCR.

Multiburst can be used but it does not provide a continuous display across the channel as does GCR and sin X/X.

The NTC-7 combination signal is the least ideal. It would be useful for relative measurements. The frequency burst's lengths are not equal and too short in duration for the 300 kHz resolution bandwidth to capture them accurately. Some modified NTC 7 combination test signals have near equal pulse widths and are more suitable for this test.

Refer to "In-channel frequency response test" in Chapter 2 for illustrations of the various test signals.

In-Channel Frequency Response Test Description

The following steps must be considered when performing these measurements:

1. An appropriate test signal must be present or the test will not return meaningful results.
2. Multiple test signals may be present and may return different results due to their point of origin.
3. Commercial insertion equipment may cause test signals to not be transmitted.

If this occurs during a test, the results will not be valid.

4. Visual signal levels greater than +20 dBmV will provide best results.
5. Non-standard timing in signal composition may not yield specified accuracy.

Surveying your system for test signal types and locations for each channel will simplify test plan generation. Blank charts are located in Chapter

9. Copy these charts and fill in appropriate information using channel measurement mode.

Relative Measurements A channel could be measured coming into the headend processing equipment and compared to that leaving the headend to determine the headend equipment's effect.

FM Deviation Test Description

Note that to perform this measurement, Option 102 is required on HP 8590 E-Series cable TV analyzers. This option is standard for the HP 8591C analyzer.

The FM deviation test reports the maximum peak deviation found during 25 sweeps (or cycles). The number of cycles per measurement can be adjusted by pressing **CYCLES/MSMT** in Channel mode.

The maximum and minimum deviations are held for the number of sweeps set in **CYCLES/MSMT** . The peak-to-peak result is calculated then divided by 2 to get peak deviation. If a test signal were used, the peak deviation could be measured in one sweep. Live audio is normally used with **CYCLES/MSMT** set to 25 or more to ensure that peak deviations are found and results are consistent.

The peak FM deviation result is the sum of all the components of the FM signal at an instant in time. This is controlled by the program material and whether it is mono, stereo, second audio program, etc.

Cross Modulation Test Description

The cross modulation test measures the first 15.7 kHz cross modulation sideband relative to the visual carrier of the channel.

Note that this test is only available in Channel mode.

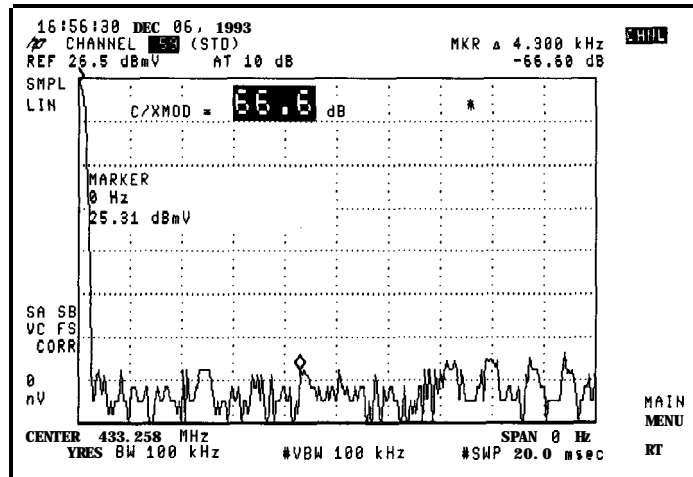

Figure 8-18. Cross Modulation

Modulation must be turned off in order to perform this test.

The analyzer is tuned to the carrier frequency and put in zero span. A fast fourier transform is performed on the signal and the magnitude of the 15.7 kHz incidental modulation is measured relative to the carrier.

System Frequency Response Test Description

This test is used to compare the frequency response at a reference point in the system to any other points in the system. It can also be used to see how the frequency response changes with time or temperature.

Start frequency, stop frequency, resolution bandwidth, video bandwidth, and reference level should be the same for the reference trace as the measurement trace. If two points are compared that have greater than 8 dB gain difference, the reference level can be adjusted to position the trace on the display.

The system frequency response test measures cable TV distribution system flatness without the need for a sweep generator or other signal source. This measurement technique does not require shutting down the system, does not interfere with any signals on the system, and works on systems with or without horizontal-sync suppression scrambling. If channels are scrambled, any time-varying scrambling should be disabled.

Note that this test is only available in Channel mode.

View Ingress Test Description

The view ingress test measures any unwanted signals from outside the cable TV system which can cause degradation of the receiver's quality.

The view ingress test places a reference marker at the peak carrier level and activates the delta marker so that you can position it on the unwanted signal. The LISTEN AT MKR function allows you to listen to the signal to help determine the source.

Note that this test is only available in Channel mode.

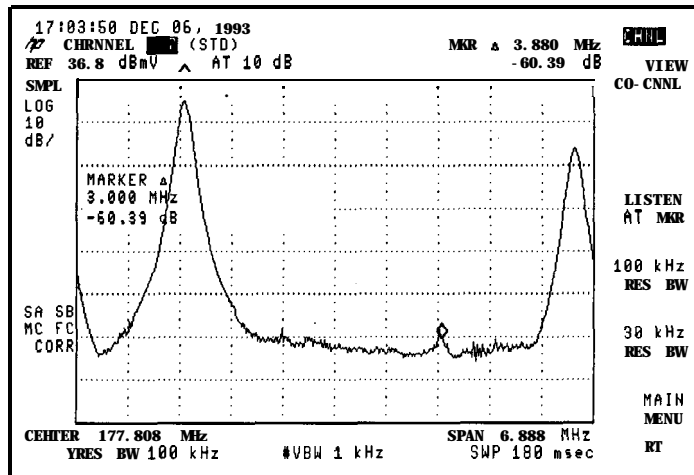

Figure 8-19. View Ingress

View Co-Channel Test Description

The view co-channel test measures the frequency and level of two signals within the same channel and within pickup distance of each other. If the co-channel level is high enough, the TV receiver will display two separate signals on one channel.

Note that this test is only available in Channel mode.

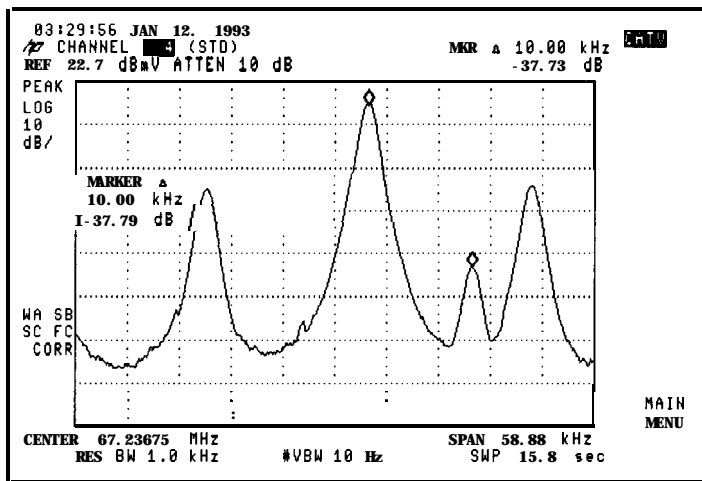

Figure E-20. View Co-Channel

Test Descriptions

View Co-Channel Test Description



Specifications and Test
Aids

Specifications and Test Aids

What You'll Find in This Chapter

This chapter outlines the specifications and characteristics of the HP 85721A cable TV measurements and system monitor personality with supported analyzers. In addition, test aids are provided. This chapter contains the following sections:

- cable TV measurement specifications and characteristics
- channel identification plans
- channel survey map

Cable TV Measurement Specifications and Characteristics

Specifications describe the warranted performance of the HP 85721A cable TV measurements and system monitor personality with supported analyzer over the temperature range of 0 °C to 55 °C,. The analyzer will meet its specifications after 2 hours of storage at a constant temperature within the operating temperature range, 30 minutes after the analyzer is turned on, and after CAL FREQ, CAL AMPTD have been run.

Characteristics provide useful, but non-warranted, information in the form of typical, nominal, or approximate values for analyzer performance.

Input Configuration	
Select input conditions of spectrum analyzer.	
75 Ω Spectrum Analyzer	No selection required
50 Ω Spectrum Analyzer	Measurements converted to 75 Ω values
50 Ω Spectrum Analyzer Selections:	
HP 8590 Series Option 711 Ext Pad	Amplitude offset set to 5.8 dB
No Ext Pad	Amplitude offset set to zero

Channel Selection	
Tune Configuration	Analyzer tunes to specified channels based upon selected tune configuration.
Channel Range	Standard, Off-the Air, HRC, IRC (T and FM channels also in channel model)
Channel Frequencies	1 to 158 and 201 to 300 [channel mode] 1 to 158 [system model] 2 to 134 [Option 1071]
Frequency Range	Defined by Code of Federal Regulations, Title 47, Telecommunications, Parts 73.603, 76.605, 76.612
Amplitude Range	5 to 1002 MHz [channel model] 54 to 896 MHz [system model] 50 to 850 MHz [Option 1071] -15 to +70 dBmV for S/N > 30 dB

Visual-Carrier Frequency	Visual-carrier frequency is counted
--------------------------	-------------------------------------

Cable TV Measurement Specifications and

Characteristics

Precision Frequency Reference (Standard)	
Resolution	100 Hz
Accuracy	$\pm(1.2 \times 10^{-7} \times \text{carrier frequency} + 110 \text{ Hz})$
@55.25 MHz (Ch. 21)	$\pm 117 \text{ Hz}$
@325.25 MHz (Ch. 411)	f149 Hz
@643.25 MHz (Ch. 941)	$\pm 187 \text{ Hz}$

Option 704 Frequency Reference*	
Resolution	1 kHz
Accuracy	$\pm(7.5 \times 10^{-6} \times \text{carrier frequency} + 110 \text{ Hz})$
@55.25 MHz (Ch. 21)	$\pm 524 \text{ Hz}$
@325.25 MHz (Ch. 411)	f2.55 kHz
@643.25 MHz (Ch. 941)	34.93 kHz

* Will not meet FCC frequency accuracy requirements.

Visual-to-Aural Carrier Frequency Difference	Frequency difference between visual and aural carriers is counted
Difference Range	4.1 to 4.9 MHz
Resolution	100 Hz
Accuracy	$\pm 221 \text{ Hz}$ for precision frequency ref (std) $\pm 254 \text{ Hz}$ for Option 704 frequency ref

Visual-Carrier Level	The peak amplitude of the visual carrier is measured to an absolute standard traceable to the National Institute of Standards and Technology.
Amplitude Range	-15 to +70 dBmV
Resolution	0.1 dB
Absolute Accuracy	$\pm 2.0 \text{ dB}$ for S/N > 30 dB
Relative Accuracy	$\pm 1.0 \text{ dB}$ relative to adjacent channels in frequency $\pm 1.5 \text{ dB}$ relative to all other channels

Visual-to-Aural Carrier level Difference	The difference between peak amplitudes of the visual and aural carrier is measured.
Difference Range	0 to 25 dB
Resolution	0.1 dB
Accuracy	$\pm 0.75 \text{ dB}$ for S/N > 30 dB

Depth of Modulation (characteristic)	Percent AM is measured from horizontal sync tip to maximum video level; measurement requires a white-reference VITS and may not be valid for scrambled channels.
AM Range	50 to 93%
Resolution	0.1%
Accuracy	$\pm 2.0\%$ for C/N > 40 dB

Digital Channel Power	Measurement Characteristic
Accuracy	± 1.0 dB for 6 MHz channel bandwidth and 10 averages

FM Deviation (characteristic)	Peak reading of FM deviation
Range	± 100 kHz
Resolution	100 Hz
Accuracy	± 1.5 kHz

Hum/Low-Frequency Disturbance	Power-line frequency and low-frequency disturbance measured on modulated and/or unmodulated carriers. May not be valid for scrambled channels.
AM Range	0.5 to 10%
Resolution	0.1%
Accuracy	$\pm 0.4\%$ for hum $\leq 3\%$ $\pm 0.7\%$ for hum $\leq 5\%$ $\pm 1.3\%$ for hum $\leq 10\%$

Visual Carrier-to-Noise Ratio (C/N)*	The C/N is calculated from the visual-carrier peak level and the minimum noise level, normalized to 4 MHz noise bandwidth.
Optimum Input Range	See Graphs [†]
Maximum C/N Range	Input level dependent - See graphs [†]
C/N Resolution	0.1 dB
C/N Accuracy	Input level and measured C/N dependent ± 1.0 to ± 3.5 dB over optimum input range

*A preamplifier and preselector filter may be required to achieve specifications.

[†]Optimum input range is determined at the time of measurement since a total input power measurement is first done to automatically set the attenuator.

Cable TV Measurement Specifications and

Characteristics

CSO and CTB Distortion*	Manual composite second order (CSO) and composite triple beat (CTB) distortions are measured relative to the visual carrier peak and require momentary disabling of the carrier. Automatic measurements are made in the channel above the channel selected and assumes that it is unused. If the analyzer has Option 107, a non-interfering CSO measurement can be made.
Optimum Input Range	See Graphs [†]
Maximum CSO/CTB Range	Input level dependent See Graphs [†] 66 to 73 dB over optimum input range
Manual CSO/CTB Resolution	0.1 dB
System CSO/CTB Resolution	1 dB
CSO/CTB Accuracy	Input level and measured CSO/CTB dependent - See graphs f1.5 dB to f4.0 dB over optimum input range

*A preamplifier and preselector filter may be required to achieve specifications.

[†]Optimum input range is determined at the time of measurement since a total input power measurement is first done to automatically set the attenuator.

C/N, CSO, and CTB Measurements

The following graphs summarize the HP 85721A personality characteristics for C/N, CSO, and CTB testing on cable TV systems with up to 77 channels and no amplitude tilt. C/N, CSO, and CTB measurement accuracies and ranges can be read from the relevant graphs. They depend upon the visual carrier peak level and the measurement reading and the total power input to the analyzer. See Chapter 8 for test descriptions for each test.

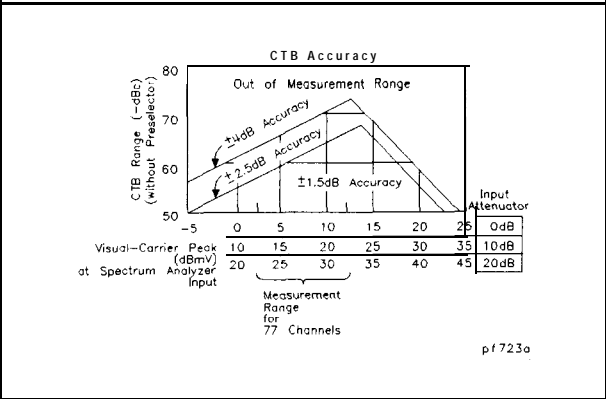
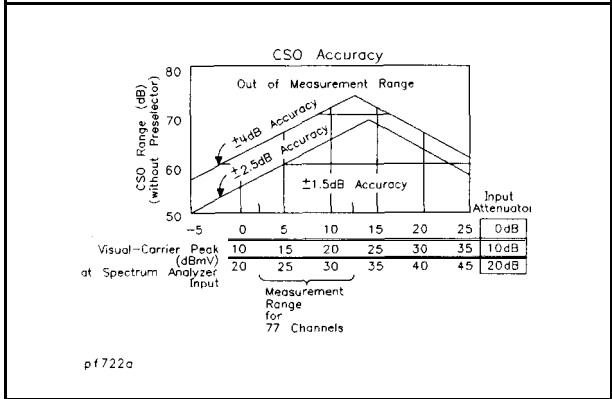
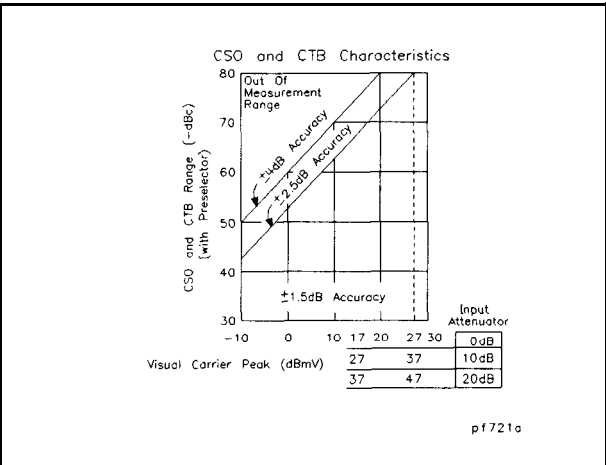
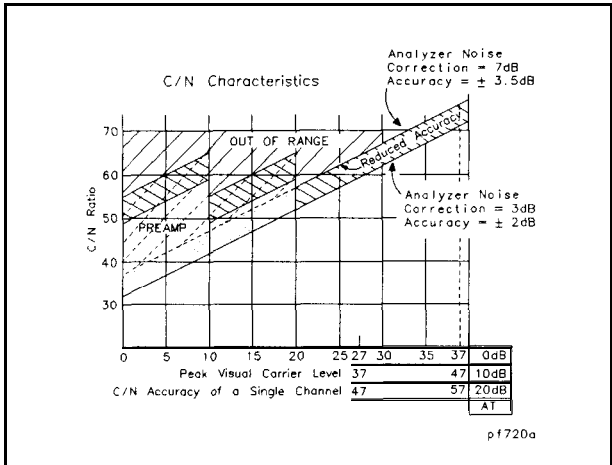

Crossmodulation

Range

Resolution

Accuracy

Horizontal-line 115.7 kHz related AM is measured on the unmodulated visual carrier.

60 dB, usable to 65 dB

0.1 dB

± 2.0 dB for x mod. < 40 dB, C/N > 40 dB

± 2.6 dB for x mod. < 50 dB, C/N > 40 dB

± 4.6 dB for x mod. < 60 dB, C/N > 40 dB

System Frequency Response (flatness)

System amplitude variations are measured relative to a reference trace stored during the setup.

Frequency Response Setup	
Fast Sweep Time	2 s (default) for no scrambling
Slow Sweep Time	8 s (default) for fixed-amplitude scrambling
Reference-Trace Storage	50 traces that include analyzer states

Frequency Response Test	
Range	1.0 dB/Div to 2.0 dB/Div (2 dB default)
Resolution	0.05 dB
Trace-flatness Accuracy	± 0.1 dB per dB deviation from a flat line and ± 0.75 dB maximum cumulative error
Trace-Position Accuracy	0.0 dB for equal temperature at test locations and 0.4 dB max for different ambient temperatures

Video Measurements

(Option 107 required; appropriate TV line must be selected)

Non-interfering color Differential Gain Accuracy Differential Phase Accuracy Chroma-Luminance Delay Inequality Accuracy Frequency Range Amplitude Range Coupler [HP part number 095507041]	(requires FCC composite or NTC-7 composite test signal) 6% 50 averages (default) 4% * 4° 50 averages (default) 3° * ±45ns 50 MHz to 850 MHz +10 dBmV to +50 dBmV at coupler input (10 dB loss) Insertion loss: < 2 dB Coupled output: -9 dB ±0.5 dB
*For +20 dBmV signal level at coupler input end room temperature.	

Non-Interfering Tests with Gate On' C/N and CSO (quiet line must be selected) In-channel Frequency Response Accuracy within channel	See graphs for accuracy [†] ±0.5 dB within channel (HP 8591C only) f 0.75 dB ≤ 85 MHz (HP 8590 E-Series) f 0.50 dB > 85 MHz (HP 8590 E-Series)
†Optimum input range is determined at the time of measurement since a total input power measurement is first done to automatically set the attenuator.	

Channel Identification Plans

Table 9-1.
FCC Numerical Designation of Television Channels (Section 73.603)

Channel Number	Frequency Band (MHz)
2	54-60
3	60-66
4	66-72
5	76-82
6	82-88
7	174-180
8	180-186
9	186-192
10	192-198
11	196-204
12	204-210
13	210-216
14	470-476
15	476-482
16	482-488
17	488-494
18	494-500
19	500-506
20	506-512
21	512-518
22	518-524
23	524-530
24	530-536
25	536-542
26	542-548
27	548-554
28	554-560
29	560-566
30	566-572

Table 9-1.
FCC Numerical Designation of Television Channels (Section 73.603)
(continued)

Channel Number	Frequency Band (MHz)
31	572-578
32	578-584
33	584-590
34	590-596
35	596-602
36	602-608
37	608-614
38	614-620
39	620-626
40	626-632
41	632-638
42	638-644
43	644-650
44	650-656
45	656-662
46	662-668
47	668-674
48	674-680
49	680-686
50	686-692
51	692-698
52	698-704
53	704-710
54	710-716
55	716-722
56	722-728
57	726-734
58	734-740
59	740-746
60	746-752
61	752-758
62	758-764

Table 9-1.
FCC Numerical Designation of Television Channels (Section 73.603)
(continued)

Channel Number	Frequency Band (MHz)
63	764-770
64	770-776
65	776-782
66	782-788
67	788-794
68	794-800
69	800-806

Table 9-2.
Channel Identification Plan
EIA Interim Standard No. 6 (CP) and FCC Part 76.612

Channel Designation	Picture Carrier Frequency (MHz)			Historical Reference
	STD	HRC	IRC	
1	N/A	72.0036	73.2625	4+, A-8
2	55.25	54.0027	55.2625	
3	61.25	60.0030	61.2625	
4	67.25	66.0033	67.2625	
5	77.25	78.0039	79.2625	
6	83.25	84.0042	85.2625	
7	175.25	174.0087	175.2625	
8	181.25	180.0090	181.2625	
9	187.25	186.0093	187.2625	A-7(HRC,IRC) A-6(HRC,IRC)
10	193.25	192.0096	193.2625	
11	199.25	198.0099	199.2625	A B C D E F G H
12	205.25	204.0102	205.2625	
13	211.25	210.0105	211.2625	
14	121.2625	120.0060	121.2625	
15	127.2625	126.0063	127.2625	
16	133.2625	132.0066	133.2625	
17	139.25	138.0069	139.2625	
18	145.25	144.0072	145.2625	
19	151.25	150.0075	151.2625	
20	157.25	156.0078	157.2625	
21	163.25	162.0081	163.2625	J K L M N O P
22	169.25	168.0084	169.2625	
23	217.25	216.0108	217.2625	
24	223.25	222.0111	223.2625	
25	223.2625	228.0114	229.2625	
26	235.2625	234.0117	235.2625	
27	241.2625	240.0120	241.2625	
28	247.2625	246.0123	247.2625	
29	253.2625	252.0126	253.2625	

Specifications and Test Aids
Channel Identification Plans

Table 9-2.
Channel Identification Plan
EIA Interim Standard No. 6 (CP) and FCC Part 76.612 (continued)

Channel Designation	Picture Carrier Frequency (MHz)			Historical Reference
	STD	HRC	IRC	
30	259.2625	258.0129	259.2625	Q
31	265.2625	264.0132	265.2625	R
32	271.2625	270.0135	271.2625	S
33	271.2625	276.0138	277.2625	T
34	283.2625	282.0141	283.2625	U
35	289.2625	288.0144	289.2625	V
36	295.2625	294.0147	295.2625	W
37	301.2625	300.0150	301.2625	X
38	307.2625	306.0153	307.2625	Y
39	313.2625	312.0156	313.2625	Z
40	319.2625	318.0159	319.2625	DD
41	325.2625	324.0162	325.2625	EE
42	331.2750*	330.0165	331.2750*	FF
43	337.2625	336.0168	337.2625	GG
44	343.2625	342.0171	343.2625	HH
45	349.2625	348.0174	349.2625	II
46	355.2625	354.0177	355.2625	JJ
47	361.2625	360.0180	361.2625	KK
48	367.2625	366.0183	367.2625	LL
49	373.2625	372.0186	373.2625	MM
50	379.2625	378.0189	379.2625	NN
51	385.2625	384.0192	385.2625	OO
52	391.2625	390.0195	391.2625	PP
53	397.2625	396.0198	397.2625	QQ
54	403.25	402.0201	403.2625	RR
55	409.25	408.0204	409.2625	SS
This frequency deviates from the pattern.				

Table 9-2.
Channel Identification Plan
EIA Interim Standard No. 6 (CP) and FCC Part 76.612 (continued)

Channel Designation	Picture Carrier Frequency (MHz)			Historical Reference
	STD	HRC	IRC	
56	415.25	414.0207	415.2625	TT
57	421.25	420.0210	421.2625	UU
58	427.25	426.0213	427.2625	VV
59	433.25	432.0216	433.2625	WW
60	439.25	438.0219	439.2625	XX
61	445.25	444.0222	445.2625	YY
62	451.25	450.0225	451.2625	22
63	457.25	456.0228	457.2625	
64	463.25	462.0231	463.2625	
65	469.25	468.0234	469.2625	
66	475.25	474.0237	475.2625	
67	481.25	480.0240	481.2625	
68	487.25	486.0243	487.2625	
69	493.25	492.0246	493.2625	
70	499.25	498.0249	499.2625	
71	505.25	504.0252	505.2625	
72	511.25	510.0255	511.2625	
73	517.25	516.0258	517.2625	
74	523.25	522.0261	523.2625	
75	529.25	528.0264	529.2625	
76	535.25	534.0267	535.2625	
77	541.25	540.0270	541.2625	
78	547.25	546.0273	547.2625	
79	553.25	552.0276	553.2625	
80	559.25	558.0279	559.2625	
81	565.25	564.0282	565.2625	
82	571.25	570.0285	571.2625	

Specifications and Test Aids
Channel Identification Plans

Table 9-2.
Channel Identification Plan
EIA Interim Standard No. 6 (CP) and FCC Part 76.612 (continued)

Channel Designation	Picture Carrier Frequency (MHz)			Historical Reference
	STD	HRC	IRC	
83	577.25	576.0288	577.2625	
84	583.25	582.0291	583.2625	
85	589.25	588.0294	589.2625	
86	595.25	594.0297	595.2625	
87	601.25	600.0300	601.2625	
88	607.25	606.0303	607.2625	
89	613.25	612.0306	613.2625	
90	619.25	618.0309	619.2625	
91	625.25	624.0312	625.2625	
92	631.25	630.0315	631.2625	
93	637.25	636.0318	637.2625	
94	643.25	642.0321	643.2625	
95	91.25	90.0045	91.2625	A-5
96	97.25	96.0048	97.2625	A-4
97	103.25	102.0051	103.2625	A-3
98	109.2750*	108.0250	109.2750*	A-2
99	115.2750*	114.0250	115.2750*	A-1
100	649.2500	648.0324	649.2625	
101	655.2500	654.0327	655.2625	
102	661.2500	660.0330	661.2625	
103	667.2500	666.0333	667.2625	
104	673.2500	672.0336	673.2625	
105	679.2500	678.0339	679.2625	
106	685.2500	684.0342	685.2625	
107	691.2500	690.0345	691.2625	
108	697.2500	696.0348	697.2625	
109	703.2500	702.0351	703.2625	
110	709.2500	708.0354	709.2625	

*This frequency deviates from the pattern.

Table 9-2.
Channel Identification Plan
EIA Interim Standard No. 6 (CP) and FCC Part 76.612 (continued)

Channel Designation	Picture Carrier Frequency (MHz)			Historical Reference
	STD	HRC	IRC	
111	715.2500	714.0357	715.2625	
112	721.2500	720.0360	721.2625	
113	727.2500	726.0363	727.2625	
114	733.2500	732.0366	733.2625	
115	739.2500	738.0369	739.2625	
116	745.2500	744.0372	745.2625	
117	751.2500	750.0375	751.2625	
118	757.2500	756.0378	757.2625	
119	763.2500	762.0381	763.2625	
120	769.2500	768.0384	769.2625	
121	775.2500	774.0387	775.2625	
122	781.2500	780.0390	781.2625	
123	787.2500	786.0393	787.2625	
124	793.2500	792.0396	793.2625	
125	799.2500	798.0399	799.2625	
126	805.2500	804.0402	805.2625	
127	811.2500	810.0405	811.2625	
128	817.2500	816.0408	817.2625	
129	823.2500	822.0411	823.2625	
130	829.2500	828.0414	829.2625	
131	835.2500	834.0417	835.2625	
132	841.2500	840.0420	841.2625	
133	847.2500	846.0423	847.2625	
134	853.2500	852.0426	853.2625	
135	859.2500	858.0429	859.2625	
136	865.2500	864.0432	865.2625	
137	871.2500	870.0435	871.2625	
138	877.2500	876.0438	877.2625	
139	883.2500	882.0441	883.2625	

Specifications and Test Aids
Channel Identification Plans

Table 9-2.
Channel Identification Plan
 EIA Interim Standard No. 6 (CP) and FCC Part 76.612 (continued)

Channel Designation	Picture Carrier Frequency (MHz)			Historical Reference
	STD	HRC	IRC	
140	889.2500	888.0444	889.2625	
141	895.2500	894.0447	895.2625	
142	901.2500	900.0450	901.2625	
143	907.2500	906.0453	907.2625	
144	913.2500	912.0456	913.2625	
145	919.2500	918.0459	919.2625	
146	925.2500	924.0462	925.2625	
147	931.2500	930.0465	931.2625	
148	937.2500	936.0468	937.2625	
149	943.2500	942.0471	343.2625	
150	949.2500	948.0474	949.2625	
151	955.2500	954.0477	955.2625	
152	961.2500	960.0480	961.2625	
153	967.2500	966.0483	967.2625	
154	973.2500	972.0486	973.2625	
155	979.2500	978.0489	979.2625	
156	985.2500	984.0492	985.2625	
157	991.2500	990.0495	991.2625	
158	997.2500	996.0498	997.2625	

Table 9-3. FM Broadcast Channels

Channel No.	Frequency (MHz)
201	88.1
202	88.3
203	88.5
204	88.7
205	88.9
206	89.1
207	89.3
208	89.5
209	89.7
210	89.9
211	90.1
212	90.3
213	90.5
214	90.7
215	90.9
216	91.1
217	91.3
218	91.5
219	91.7
220	91.9
221	92.1
222	92.3
223	92.5
224	92.7
225	92.9
226	93.1
227	93.3
228	93.5
229	93.7
230	93.9
231	94.1
232	94.3
233	94.5
234	94.7

Channel Identification Plans

Table 9-3. FM Broadcast Channels (continued)

Channel No.	Frequency (MHz)
235	94.9
236	95.1
237	95.3
238	95.5
239	95.7
240	95.9
241	96.1
242	96.3
243	96.5
244	96.7
245	96.9
246	97.1
247	97.3
248	97.5
249	97.7
250	97.9
251	98.1
252	98.3
253	98.5
254	98.7
255	98.9
256	99.1
257	99.3
258	99.5
259	99.7
260	39.9
261	100.1
262	100.3
263	100.5
264	100.7
265	100.9
266	101.1
267	101.3
268	101.5

Table 9-3. FM Broadcast Channels (continued)

Channel No.	Frequency (MHz)
269	101.7
270	101.9
271	102.1
272	102.3
273	102.5
274	102.7
275	102.9
276	103.1
277	103.3
278	103.5
279	103.7
280	103.9
281	104.1
282	104.3
283	104.5
284	104.7
285	104.9
286	105.1
287	105.3
288	105.5
289	105.7
290	105.9
291	106.1
292	106.3
293	106.5
294	106.7
295	106.9
296	107.1
297	107.3
298	107.5
299	107.7
300	107.9

Table 9.4. T-Channels

Channel	Standard		
	Video	Color	Sound
T7	7.00	10.58	11.50
T8	13.00	16.58	17.50
T9	19.00	22.58	23.50
T10	25.00	28.58	29.50
T11	31.00	34.58	35.50
T12	37.00	40.58	41.50
T13	43.00	46.58	47.50

Channel Survey Map

The following channel survey map is intended to be used as a test aid. Line numbers of quiet lines and test signals should be documented for each channel in your system. This is especially useful when creating test plans in system measurement mode.

Make photocopies of a blank channel survey map and enter the line numbers and channel numbers corresponding to your system. Use the channel measurement mode of operation to gather this information by conducting the individual tests with PAUSE YES NO in the Setup menu set to YES, then noting where the proper test signals are found.

Channel Survey Map

Channel Number		Line Number				
	Odd					
	Even					
	Odd					
	Even					
	Odd					
	Even					
	Odd					
	Even					
	Odd					
	Even					
	Odd					
	Even					
	Odd					
	Even					
	Odd					
	Even					
	Odd					
	Even					
	Odd					
	Even					
	Odd					
	Even					
	Odd					
	Even					
	Odd					
	Even					

Channel Number		Line Number				
	Odd					
	Even					
	Odd					
	Even					
	Odd					
	Even					
	Odd					
	Even					
	Odd					
	Even					
	Odd					
	Even					
	Odd					
	Even					
	Odd					
	Even					
	Odd					
	Even					
	Odd					
	Even					
	Odd					
	Even					
	Odd					
	Even					
	Odd					
	Even					

Channel Survey Map

Channel Number		Line Number				
	Odd					
	Even					
	Odd					
	Even					
	Odd					
	Even					
	Odd					
	Even					
	Odd					
	Even					
	Odd					
	Even					
	Odd					
	Even					
	Odd					
	Even					
	Odd					
	Even					
	Odd					
	Even					
	Odd					
	Even					
	Odd					
	Even					
	Odd					
	Even					

Channel Number		Line Number				
	Odd					
	Even					
	Odd					
	Even					
	Odd					
	Even					
	Odd					
	Even					
	Odd					
	Even					
	Odd					
	Even					
	Odd					
	Even					
	Odd					
	Even					
	Odd					
	Even					
	Odd					
	Even					
	Odd					
	Even					
	Odd					
	Even					

Channel Survey Map

Channel Number		Line Number				
	Odd					
	Even					
	Odd					
	Even					
	Odd					
	Even					
	Odd					
	Even					
	Odd					
	Even					
	Odd					
	Even					
	Odd					
	Even					
	Odd					
	Even					
	Odd					
	Even					
	Odd					
	Even					
	Odd					
	Even					
	Odd					
	Even					
	Odd					
	Even					
	Odd					
	Even					

Channel Number		Line Number				
	Odd					
	Even					
	Odd					
	Even					
	Odd					
	Even					
	Odd					
	Even					
	Odd					
	Even					
	Odd					
	Even					
	Odd					
	Even					
	Odd					
	Even					
	Odd					
	Even					
	Odd					
	Even					
	Odd					
	Even					
	Odd					
	Even					

Channel Survey Map

Channel Number		Line Number				
	Odd					
	Even					
	Odd					
	Even					
	Odd					
	Even					
	Odd					
	Even					
	Odd					
	Even					
	Odd					
	Even					
	Odd					
	Even					
	Odd					
	Even					
	Odd					
	Even					
	Odd					
	Even					
	Odd					
	Even					
	Odd					
	Even					

Channel Number		Line Number				
	Odd					
	Even					
	Odd					
	Even					
	Odd					
	Even					
	Odd					
	Even					
	Odd					
	Even					
	Odd					
	Even					
	Odd					
	Even					
	Odd					
	Even					
	Odd					
	Even					
	Odd					
	Even					
	Odd					
	Even					
	Odd					
	Even					

Specifications and Test Aids

Channel Number		Line Number				
	Odd					
	Even					
	Odd					
	Even					
	Odd					
	Even					
	Odd					
	Even					
	Odd					
	Even					
	Odd					
	Even					
	Odd					
	Even					
	Odd					
	Even					
	Odd					
	Even					
	Odd					
	Even					
	Odd					
	Even					
	Odd					
	Even					
	Odd					
	Even					

———— Glossary

Glossary

active function

The active function is the instrument's feature currently selected for use. It may be a key selection or remote-programming command.

active function readout

The area of a display screen where the active function and its state are displayed. The active function is the one that was completed by the last key selection or remote-programming command.

active marker

The marker on a trace that can be repositioned by front-panel controls or programming commands.

active trace

The trace (commonly A, B, or C) that is being swept (updated) with incoming signal information.

air

See off-the-air tune configuration.

amplitude accuracy

The general uncertainty of an analyzer amplitude measurement, whether relative or absolute.

ASCII

The acronym for American Standard Code for Information Interchange. It is an eight-part code (7 bits plus parity check) used for data (information) interchange. An ASCII value is a specific combination of bits ranging from 0 to 255 that represent characters in machine language that computers and controllers can understand.

attenuation

A general term used to denote a decrease of signal magnitude in transmission from one point to another. Attenuation may be expressed as a scalar ratio of the input to the output magnitude in decibels.

aural carrier

The carrier that has the audio portion of a television channel. A television channel usually contains both a visual and aural carrier. An aural carrier is sometimes referred to as a sound carrier.

auxiliary interface

An analyzer rear-panel connector that provides control lines and power for external equipment. The auxiliary interface contains control lines A and B. The voltage levels of control lines A and B are changed by some of the HP 85721A's tests.

bandwidth selectivity

This is a measure of the analyzer's ability to resolve signals unequal in amplitude. It is the ratio of the 60 dB bandwidth to the 3 dB bandwidth for a given resolution filter (IF). Bandwidth selectivity tells us how steep the filter skirts are. Bandwidth selectivity is sometimes called shape factor.

battery-backed RAM

Random access memory (RAM) data retained by a battery. RAM memory cards can contain data that is maintained with a battery. Refer also to nonvolatile memory.

baud rate

A rate of transmission that is measured as signal events per time period. The baud rate is equal to or greater than bits per second, since one bit can consist of more than one signal event.

card reader

See memory card.

carrier-to-noise ratio

The ratio of the amplitude of the carrier to the noise power in the portion of the spectrum occupied by the carrier. Also referred to as the C/N ratio.

CATV

Abbreviation for community antenna television or cable television system. A cable television system is a broadband communications system that provides multiple channels from centralized antennas.

character set

The set of elementary symbols. These normally include both alpha and numeric codes, plus punctuation or any other symbol that may be read, stored, or written and used for organization, control, or representation of data.

chroma/luma delay inequality

This is the tune delay between the low frequency luminance component and the high frequency chrominance component of the 12.5T pulse in the test signal. Positive chroma/luma delay is when chroma lags luma in time.

command

A set of instructions that are translated into instrument actions. The actions are usually made up of individual steps that together can execute an operation. Generally, for analyzers it is a sequence of code that controls some operation of an analyzer. These codes can be keyed in via a controller, or computer. Refer also to function.

composite second order beat

Composite second order beat (CSO) is the ratio of the composite second order beat products to the peak level of the visual carrier. For a system using the standard tune configuration, the composite second order beat products are the distortion products that occur at f_{750} kHz and ± 1.25 MHz around the visual carrier.

composite triple beat

Composite triple beat (CTB) is the ratio of the composite triple beat products to the peak level of the visual carrier. The composite triple beat products are distortion products that occur at the visual carrier frequency.

continuous sweep mode

The analyzer condition where traces are automatically updated each time trigger conditions are met.

CSO

Refer to composite second order beat

CTB

Refer to composite triple beat.

current trace

The displayed trace on the analyzer screen.

default

The preset conditions, options, or parameters of an instrument. The default state may be changed by choosing key selections or writing programming commands to use other conditions.

delta marker

An analyzer mode in which a fixed reference marker is established, then a second active marker becomes available so it can be placed anywhere along the trace. A readout indicates the relative frequency separation and amplitude difference between the reference and active markers.

depth of modulation

Measures the percentage of amplitude modulation on the video carrier between the horizontal synchronization-pulse and the vertical interval test signal white level.

differential gain

This is the change in amplitude of the chrominance subcarrier as the luminance changes from a blanking level towards white level. It is measured as the difference in amplitude between the largest and smallest segments, divided by the largest and expressed in percent.

differential phase

As defined by the NTC, this is the maximum peak-to-peak change in phase of the chrominance subcarrier as the luminance changes from a blanking level towards white level.

As defined by the FCC, the greatest phase difference in degrees between each segment of the chrominance signal and the reference signal.

display dynamic range

The maximum dynamic range over which both the larger and smaller signal can be viewed simultaneously on the display. For analyzers with a maximum logarithmic display of 10 dB/division, the actual dynamic range may be greater than the display dynamic range. Refer also to dynamic range.

display fidelity

The measurement uncertainty of relative differences in amplitude on an analyzer. On purely analog analyzers (those analyzers that display trace

information immediately and do not store, then recall the data to the screen), these differences are displayed on the screen and the graticule is used to evaluate the measurement. Many analyzers with digital displays (refer to digital display) have markers that can be used to measure the signal. As a result, measurement differences are stored in memory, and the ambiguity of the display is eliminated from the measurement.

DLP

The abbreviation for downloadable program. A single programming command or a sequence of programming commands used to perform specific operations. DLPs can be made up of several functions, variables, and traces defined by the program creator. The DLP can be downloaded from one electronic storage medium into another and executed without a controller.

dynamic range

The power ratio (dB) between the smallest and largest signals simultaneously present at the input of an analyzer that can be measured with some degree of accuracy. Dynamic range generally refers to measurement of distortion or inter-modulation products.

end-of-line (EOL) readings

Measurements taken at the last tap on the distribution cable.

error message

A message displayed on the screen indicating missing or failed hardware, improper user operation, or other conditions that require additional attention. Generally, the requested action or operation cannot be completed until the condition is resolved.

FFT

The abbreviation for Fast Fourier transform. It is a mathematical operation performed on a time-domain signal to yield the individual spectral components that constitute the signal.

file

An electronic means of storing data. The data is stored as a collection of related records. The records are organized in a file.

firmware

An assembly made up of hardware and instruction code that are integrated to form a functional set that cannot be altered during normal operation. The instruction code, permanently installed in the circuitry of

the instrument, is classified as ROM (read-only memory). The Firmware determines the operating characteristics of the instrument or equipment. Each firmware version is identified by a revision code number, or date code.

FM deviation

Peak deviation of the audio FM signal of a cable TV channel.

frequency accuracy

The uncertainty with which the frequency of a signal or spectral component is indicated, either in an absolute sense or relative to some other signal or spectral component. Absolute and relative frequency accuracies are specified independently.

frequency range

The range of frequencies over which the analyzer performance is specified. The maximum frequency range of many microwave analyzers can be extended with the application of external mixers.

frequency resolution

The ability of an analyzer to separate closely spaced spectral components and display them individually. Resolution of equal amplitude components is determined by resolution bandwidth. Resolution of unequal amplitude signals is determined by resolution bandwidth and bandwidth selectivity.

frequency response

The peak-to-peak variation in the displayed signal amplitude over a specified center frequency range. Frequency response is typically specified in terms of \pm dB relative to the value midway between the extremes. It also may be specified relative to the calibrator signal.

frequency span

The magnitude of the displayed frequency component. Span is represented by the horizontal axis of the display. Generally, frequency span is given as the total span across the full display. Some analyzers represent frequency span (scan width) as a per-division value.

frequency stability

Stability is the ability of a frequency component to remain unchanged in frequency or amplitude over short- and long-term periods of time. Stability refers to the local oscillator's ability to remain fixed at a particular frequency over time. The sweep ramp that tunes the local oscillator influences where a signal appears on the display. Any long-term

variation in local oscillator frequency (drift) with respect to the sweep ramp causes a signal to shift its horizontal position on the display slowly. Shorter-term local oscillator instability can appear as random FM or phase noise on an otherwise stable signal.

front-panel key

Keys, typically labeled, located on the front panel of an instrument. The key labels identify the function the key activities. Numeric keys and step keys are two examples of front-panel keys.

full span

A mode of operation in which the analyzer scans the entire frequency band of an analyzer.

function

The action or purpose that a specific item is intended to perform or serve. The analyzer contains functions that can be executed via front-panel key selections, or through programming commands. The characteristics of these functions are determined by the Firmware in the instrument. In some cases, a DLP (downloadable program) execution of a function allows you to execute the function from front-panel key selections.

gain compression

The signal level at the input mixer of an analyzer where the displayed amplitude of the signal is a specific number of dB too low due just to mixer saturation. The signal level is generally specified for 1 dB or 0.5 dB compression and is usually between -3 dBm and -10 dBm.

gated measurements

The tests requiring Option 107 that allow carrier-to-noise, CSO, and in-channel frequency response measurements to be performed without disrupting service.

hard copy

Information or data printed onto paper as opposed to its being stored on disk or in the instrument's memory.

hardkeys

Pushbutton keys on the analyzer front panel that control frequency, span, amplitude, instrument state, markers, controls, and data functions.

HP-IB

The abbreviation for Hewlett-Packard Interface Bus. It is a Hewlett-Packard proprietary parallel interface that allows you to connect more than one device to a port on a computer or instrument. The HP-IB bus is also called the IEEE-488 bus.

in-channel frequency response

Frequency response test that measures the flatness of an individual cable TV channel.

incrementally related carriers

Incrementally related carriers (IRC), is a tune configuration where all channels except channels 5 and 6 are standard channels (see standard tune configuration for a definition of standard channels).

input attenuator

An attenuator (also called an RF attenuator) between the input connector and the first mixer of an analyzer. The input attenuator is used to adjust the signal level incident to the first mixer, and to prevent gain compression due to high-level or broadband signals. It is also used to set the dynamic range by controlling the degree of internally-generated distortion. For some analyzers, changing the input attenuator settings changes the vertical position of the signal on the display, which then changes the reference level accordingly. In Hewlett-Packard microprocessor-controlled analyzers, the IF gain is changed to compensate for changes in input attenuator settings. Because of this, the signals remain stationary on the display, and the reference level is not changed.

input impedance

The terminating impedance that the analyzer presents to the signal source. The nominal impedance for RF and microwave analyzers is usually 50 Ω . For some systems, such as cable TV, 75 Ω is standard. The degree of mismatch between the nominal and actual input impedance is called the VSWR (voltage standing wave ratio).

integer number

A whole number with no decimal or fractional part.

IRC

See incrementally related carriers.

limit line

A test limit made up of a series of line segments, positioned according to frequency and amplitude within the analyzer's measurement range. Two defined limit lines may be displayed simultaneously. One sets an upper test limit, the other sets a lower test limit. Trace data can be compared with the limit lines as the analyzer sweeps. If the trace data exceeds either the upper or lower limits, the analyzer displays a message or sounds a warning, indicating that the trace failed the test limits.

limit-line file

The user-memory Ele that contains the limit-line table entries. Limit lines are composed of frequency and amplitude components that make up a trace array and this data is stored in the Ele. The limit-line Ele feature is available on analyzers that are capable of limit-line operation. Refer also to limit line.

limit-line table

The line segments of a limit line are stored in the limit-line table. The table can be recalled to edit the line segments, then restored in the limit-line file. Refer also to limit line.

log display

The display mode in which vertical deflection is a logarithmic function of the input-signal voltage. Log display is also referred to as logarithmic mode. The display calibration is set by selecting the value of the top graticule line (reference level), and scale factor in volts per division. On Hewlett-Packard analyzers, the bottom graticule line represents 0 volts for scale factors of 10 dB/division or more. The bottom division, therefore, is not calibrated for those analyzers. Analyzers with microprocessors allow reference level and marker values to be indicated in dBm, dBmV, dB μ V, volts, and occasionally in watts. Nonmicroprocessor-based analyzers usually offer only one kind of unit, typically dBm.

marker

A visual indicator we can place anywhere along the displayed trace. A marker readout indicates the absolute value of the trace frequency and amplitude at the marked point. The amplitude value is displayed with the currently selected units.

maximum input level

The maximum signal power that may be safely applied to the input of an analyzer. Typically 1 W (-30 dBm) for Hewlett-Packard analyzers.

measurement range

The ratio, expressed in dB, of the maximum signal level that can be measured (usually the maximum safe input level) to the lowest achievable average noise level. This ratio is almost always much greater than can be realized in a single measurement. Refer also to dynamic range.

memory

A storage medium, device, or recording medium into which data can be stored and held until some later time, and from which the entire original data may be retrieved.

memory card

A small, credit-card-shaped memory device that can store data or programs. The programs are sometimes called personalities and give additional capabilities to your instrument. Typically, there is only one personality per memory card. Refer also to personality.

menu

The analyzer functions that appear on the display and are selected by pressing front-panel keys. These selections may evoke a series of other related functions that establish groups called menus.

modem

A device that enables a computer to interface with another computer or analyzer over the telephone connection. Modem is an acronym for modulator and demodulator.

non-interfering measurements

Measurements made without turning off modulation or the carrier (Option 107 required).

nonvolatile memory

Memory data that is retained in the absence of an ac power source. This memory is typically retained with a battery. Refer also to battery-backed RAM.

normalized reference level

An amplitude level representing 0 dB deviation from a calibrated system's response. It is obtained by subtracting the system's response from itself.

normalized reference position

The position on a network analyzer's display of the normalized reference level.

off-the-air tune configuration

The tune configuration for signals that are broadcast over the air and received with an antenna.

over-the-air tune configuration

See off-the-air tune configuration.

oven reference

An analyzer that has an oven reference has increased absolute frequency-reference accuracy because the internal oscillators are phase-locked to an internal precision-frequency reference

parameter units

Standard units of measure, which include the following:

Measured Parameter	Unit Name	Unit Abbreviation
frequency	hertz	HZ
power level	decibel relative to milliwatts	dBm
power ratio	decibel	dB
voltage	volt	V
time	second	s
electrical current	ampere	A
impedance (resistance)	ohm	Ω

personality

Applications available on a memory card or other electronic media that extends the capability of an instrument for specific uses. Examples include digital radio personalities and cable TV personalities.

preamplifier

An external, low-noise-Egure amplifier that improves system (preamplifier-l analyzer) sensitivity over that of the analyzer itself.

query

Any analyzer programming command having the distinct function of returning a response. These commands may end with a question mark (?). Query commands return information either to the computer or to the analyzer display.

quiet line

A horizontal line with no video modulation used when performing non-interfering measurements of carrier-to-noise and CSO.

random-access memory

RAM (random-access memory) or read-write memory, is a storage area allowing access to any of its storage locations. Data can be written to or retrieved from RAM, but data storage is only temporary. When the power is removed, the information disappears. User-generated information appearing on a display is RAM data.

read-only memory

ROM (read-only memory) that is encoded into the analyzer's firmware. The data can be accessed (read) only; it cannot be altered by the user.

real number

A positive or negative number with both a decimal and a fractional part.

reference level

The calibrated vertical position on the display used as a reference for amplitude measurement in which the amplitude of one signal is compared with the amplitude of another regardless of the absolute amplitude of either.

reference trace

The trace previously taken and later compared to the currently displayed trace. For example, a trace taken at the headend for system frequency response measurements.

resolution

Refer to frequency resolution.

resolution bandwidth

The ability of an analyzer to display adjacent responses discretely (hertz, hertz decibel down). This term is used to identify the width of the resolution bandwidth filter of an analyzer at some level below the minimum insertion-loss point (maximum deflection point on the display).

The 3 dB resolution bandwidth is specified; for others, it is the 6 dB resolution bandwidth.

RS-232

A means of communication between devices, such as printers, plotters, computers, modems, and analyzers. (The devices need to have RS-232 interfaces). Unlike the HP-IB interface bus, the RS-232 interface bus is used for serial (not parallel) transmission.

scale factor

The per-division calibration of the vertical axis of the display.

scrambled

To alter an electronic signal so that a decoding device is necessary to receive the signal.

shape factor

Refer to bandwidth selectivity.

single-sweep mode

The analyzer sweeps once when trigger conditions are met. Each sweep is initiated by pressing an appropriate front-panel key, or by sending a programming command.

softkey

Key labels displayed on a screen or monitor that are activated by mechanical keys surrounding the display or located on a keyboard. Softkey selections usually evoke menus that are written into the program software. Front-panel key selections determine which menu (set of softkeys) appears on the display.

span

Span equals the stop frequency minus the start frequency. The span setting determines the horizontal-axis scale of the analyzer display.

span accuracy

The uncertainty of the indicated frequency separation of any two signals on the display.

spectrum analyzer

A device that effectively performs a Fourier transform and displays the individual spectral components (sine waves) that constitute a time-domain signal.

standard tune configuration

The tune configuration in which the channels are at the frequencies that the Electronic Industries Association (EIA) and FCC define to be the standard channel frequencies.

STD

See standard tune configuration

stop/start frequency

Terms used in association with the stop and start points of the frequency measurement range. Together they determine the span of the measurement range.

sweep time

The time it takes the local oscillator to tune across the selected span. Sweep time directly affects how long it takes to complete a measurement. It does not include the dead time between the completion of one sweep and the start of the next. It is usually a function of frequency span, resolution bandwidth, and video bandwidth. Resolution affects sweep time in that the IF Elters are band-limited circuits requiring finite times to charge and discharge. The amount of time the mixing product remains in the IF filter passband is directly proportional to the bandwidth; inversely proportional to the sweep in Hz per unit of time. The rise time of a Elter is inversely proportional to its bandwidth, and if the proportionality constant “k” is included, then we can make the rise time equal the “k” divided by resolution bandwidth. Mathematically, this is represented as:

$$\begin{aligned} \text{Time in Passband} &= \frac{\text{resolution bandwidth}}{(\text{span sweep time})} \\ &= \frac{(\text{resolution bandwidth} \times \text{sweep time})}{\text{span}} \end{aligned}$$

$$\text{Rise Time} = \frac{k}{\text{resolution bandwidth}}$$

Solving for sweeptime:

$$\text{Sweep Time} = \frac{k \times \text{span}}{\text{resolution bandwidth}^2}$$

synchronization pulse

A transmitted pulse that is used to synchronize the electron beam of a picture monitor with the modulation of the transmission source.

syntax

The grammar rules that specify how commands must be structured for an operating system, programming language, or applications.

system frequency response

Frequency response test that measures the flatness of the entire system.

trace

A trace is made up of a series of data points containing frequency and amplitude information. The series of data points is often referred to as an array. Traces A, B, and C are the typical names of traces that the analyzer displays. The number of traces is specific to the instrument.

tune configuration

Tune configuration refers to the correlation between the channel numbers and the frequency to which a channel is assigned. For example, the frequency at which channel 1 is broadcast differs between the HRC and IRC tune configurations. The HP 85721A can be configured for four different tune configurations—STD, AIR, IRC, and HRC.

units

Dimensions on the measured quantities. Units usually refer to amplitude quantities because they can be changed. In analyzers with microprocessors, available units are dBm (dB relative to 1 mW dissipated in the nominal input impedance of the analyzer), dBmV (dB relative to 1 mV), dB μ V (dB relative to 1 μ V), volts, and, in some analyzers, watts.

unscrambled

A signal that has not been scrambled. An unscrambled signal does not need a decoder to receive the signal correctly.

update

To make existing information current; to bring information up to date.

variable

A variable can be assigned a value. The value assigned to a variable can be changed.

vertical interval test signal

The vertical interval test signal (VITS) is a signal that may be included during the vertical blanking interval to permit in-service testing and adjustment of video transmission.

video

A term describing the output of an analyzer's envelope detector. The frequency range extends from 0 Hz to a frequency that is typically well beyond the widest resolution bandwidth available in the analyzer. However, the ultimate bandwidth of the video chain is determined by the setting of the video filter. Video is also a term describing the television signal composed of visual carriers/modulation.

video average

The digital averaging of analyzer trace information. It is available only on analyzers with digital displays. Each point on the display is averaged independently and the average is computed based on the number of sweeps selected by the user. The averaging algorithm applies a factor to the amplitude value of a given point on the current sweep ($1/n$, where n is the number of the current sweep); applies another factor to the previously stored average [$(n - 1/n)$]; and combines the two for a current average. After the designated number of sweeps are completed, the factors remain constant, and the display becomes a running average.

video bandwidth

The cut-off frequency (3 dB point) of an adjustable low-pass filter in the video circuit. When the video bandwidth is equal to or less than the resolution bandwidth, the video circuit cannot fully respond to the more rapid fluctuations of the output of the envelope detector. The result is a smoothing of the trace, or a reduction in the peak-to-peak excursion, of broadband signals such as noise and pulsed RF when viewed in broadband mode. The degree of averaging or smoothing is a function of the ratio of the video bandwidth to the resolution bandwidth.

video filter

A post-detection, low-pass filter that determines the bandwidth of the video amplifier. It is used to average or smooth a trace. Refer also to video bandwidth.

visual carrier

The visual carrier is the portion of a television signal that contains the picture. A television signal contains both a visual and an aural carrier.

white level

The level of a visual carrier that corresponds to the maximum level of the white area for a picture signal.

zero span

The case in which an analyzer's local oscillator remains fixed at a given frequency so that the analyzer becomes a fixed-tuned receiver. In this state, the bandwidth is equal to the resolution bandwidth. Signal amplitude variations are displayed as a function of time. To avoid loss of signal information, the resolution bandwidth must be as wide as the signal bandwidth. To avoid any smoothing, the video bandwidth must be set wider than the resolution bandwidth.

video

A term describing the output of an analyzer's envelope detector. The frequency range extends from 0 Hz to a frequency that is typically well beyond the widest resolution bandwidth available in the analyzer. However, the ultimate bandwidth of the video chain is determined by the setting of the video filter. Video is also a term describing the television signal composed of visual carriers/modulation.

video average

The digital averaging of analyzer trace information. It is available only on analyzers with digital displays. Each point on the display is averaged independently and the average is computed based on the number of sweeps selected by the user. The averaging algorithm applies a factor to the amplitude value of a given point on the current sweep ($1/n$, where n is the number of the current sweep); applies another factor to the previously stored average $[(n - 1)/n]$; and combines the two for a current average. After the designated number of sweeps are completed, the factors remain constant, and the display becomes a running average.

video bandwidth

The cut-off frequency (3 dB point) of an adjustable low-pass filter in the video circuit. When the video bandwidth is equal to or less than the resolution bandwidth, the video circuit cannot fully respond to the more rapid fluctuations of the output of the envelope detector. The result is a smoothing of the trace, or a reduction in the peak-to-peak excursion, of broadband signals such as noise and pulsed RF when viewed in broadband mode. The degree of averaging or smoothing is a function of the ratio of the video bandwidth to the resolution bandwidth.

video filter

A post-detection, low-pass filter that determines the bandwidth of the video amplifier. It is used to average or smooth a trace. Refer also to video bandwidth.

visual carrier

The visual carrier is the portion of a television signal that contains the picture. A television signal contains both a visual and an aural carrier.

white level

The level of a visual carrier that corresponds to the maximum level of the white area for a picture signal.

Index

Index

- 1** 100 kHz RES BW key, 2-60
12.5T pulse, 8-35

- 2** 2T pulse, 8-35

- 3** 30 kHz RES BW key, 2-60

- 5** 50 ohm input analyzer, 2-5, 3-5
5th PKT YES NO key, 2-39

- A** ABORT description, 6-6
 - ABORT key, 3-15
 - access cable TV analyzer mode, 1-14
 - accessing spectrum analyzer mode, 2-62, 3-18
 - accessing the memory card, 1-6
 - accessing the TV receiver mode, 2-63, 3-19
 - AIR description, 7-6
 - AIR key, 2-4, 3-4
 - ALL TESTS description, 6-6
 - ALL TESTS key, 3-23, 3-25
 - ALREADY ENTERED error message, 4-3
 - amplifier adjust, real-time, 2-59
 - amplifier, select external, 7-1 1
 - amplitude ripple, 5-14
 - amplitude slope, 5-14
 - ANALOG+ ON OFF key, 2-35
 - analyzer, description of, x
 - Analyzer Input description, 7-7
 - Analyzer Input key, 2-5, 3-6
 - analyzer operation, xiv
 - ATTEN STEP DN key, 2-27
 - ATTEN STEP UP key, 2-27
 - attenuation selection, 2-9
 - audio volume, 5-19
 - aural carrier, 5-10
 - auto quiet line search, 2-16
 - auto search, test signal, 2-22
 - AUTO SIG SEARCH key, 2-23, 2-39
 - auto test signal search, diff gain/phase, 2-37
 - AUX CTRL key, 2-63, 3-19

auxiliary interface, 8- 19
AVERAGE ON OFF key, 2- 18, 5- 18

B back space key, 3-10
BAUD RATE key, 1-11
beat level, changes with attenuation, 2-27
beats, measure between standard offsets, 2-27
BK SP key, 3-10, 3-22, 3-31
BLANK CARD key, 3-38

C cable TV analyzer
 how to access, 1-14
CABLE TV ANALYZER key, 2-11, 5- 10
cable TV signal, connect, 2-9
cable TV signal, connecting, 2-10
CAL FREQ & AMPTD key, 1-8
CAL FREQ key, 1-8
calibration
 frequency, 1-8
 frequency and amplitude, 1-8
 storing the results, 1-8
CAL STORE key, 1-8
Card Config key, 3-37
CARRIER LVL&FRQ key, 2- 12
CARRIER/NOISE key, 2- 15
carrier to noise
 display calculation, 2- 19
 preamplifier needed, 2- 19
carrier-to-noise ratio test, 8-7
CATALOG ALL key, 3-39
catalog analyzer memory, 3-33
catalog a RAM card, 3-36
CATALOG CARD description, 6-7
Catalog Card key, 3-39
CATALOG CARD key, 3-36
cataloging the RAM or ROM card, 6-7
Catalog Internal key, 3-33
CATALOG REGISTER key, 3-33
catalog the saved test plans, 3-33
caution
 the caution symbol, viii
CAUTION - Recalled Test Plan Corrupted error message, 4-4
CAUTION - STOP TIME ALREADY PASSED error message, 4-4
CAUTION - STOP TIME LESS THAN START TIME error message, 4-5
CENTER FREQ key, 2-58, 5-14
center frq, user defined channel, 7-21
CHANGE TITLE key, 3-28
channel format

- AIR, 2-4, 3-4, 5-9
 - displayed position, 3-4
- HRC, 2-4, 3-4, 5-9
- IRC, 2-4, 3-4, 5-9
- STD, 2-4, 3-4, 5-9
- T, 2-4, 3-4, 5-9
- channel measurements, list of, 2-2
- channel number range, 6-18
- channel numbers, 5-10
- channel numbers, entering, 5-10
- channel numbers, valid, 3-23
- CHANNEL SELECT description, 5-9, 7-8
- channel selection, view, 6-36
- CHANNEL SELECT key, 2-11, 2-63
- channel survey map, 3-22, 9-23
- Channel Tuning description, 7-8
- Channel Tuning key, 2-4, 3-4
- characteristics, 9-3
 - carrier to noise, 9-6
 - CSO/CTB, 9-6
- CHECK CARD IN SLOT error message, 4-5
- chroma/luma delay, 2-22
- CLDI key, 2-22
- clearing the test plan, 6-9
- CLEAR TESTS description, 6-9
- CLEAR TESTS key, 3-23, 3-25
- clear the current test plan, 3-32
- CLEAR TST PLAN description, 6-9
- CLEAR TST PLAN key, 3-22, 3-32
- clock
 - setting the time and date, 4-15
- composite second order test, 8-16
- composite tripe beat test, 8-18
- CONFIG key, 1-11, 3-37
- connect cable TV signal, 2-9, 3-8
- connecting analyzer to a printer, 1-10
- connecting cable TV signal, 2-10
- contents of a printout, 6-10
- CONTINUE key, 2-17, 2-24, 2-27, 2-40, 2-52, 2-57, 5-17
- control line B, 8-19
- CONTS SWEEP key, 2-58, 5-15
- COPY key, 2-12, 2-19, 2-25, 2-28, 2-30, 2-35, 2-41, 2-46, 2-48
- correction constants, 1-8
- coupler, 2-9, 3-8
- Create Tstplan key, 3-22
- Create TstPlan key, 3-23, 3-31
- creating a test plan, 3-22
- CROSSMOD key, 2-30
- cross modulation test, 8-44

- CSO beats, improve presentation, 2-27
- CSO/CTB, gated version, 2-26
- CSO/CTB key, 2-26
- CSO FREQ OFFSET description, 7-9
- CSO FREQ OFFSET key, 3-7, 3-14
- CTB FREQ OFFSET description, 7-9
- CTB FREQ OFFSET key, 3-7, 3-14
- CTB STEP DN key, 2-27
- CTB STEP UP key, 2-27
- CYCLES/MSMT key, 2-46

D data fields

- if a “-” appears, 4-13
- DATA TO PRINTER description, 6-10
- DATA TO PRINTER key, 3-35
- DATA TO SCREEN key, 3-35
- data type, 6-7
- date
 - setting the date, 4-15
- default configuration, 7-15
- default fields, 2-7, 3-7
- default line numbers, 2-7, 3-7
- default test signal line, CLDI, 2-22
- definitions
 - characteristics, 9-3
 - specifications, 9-3
- DELETE FILE key, 3-39
- delete files from a RAM card, 3-38
- delete HP 85721A personality, 1-15
- delete individual files from RAM card, 3-39
- deleting a channel from the test plan, 3-31
- deleting a test for a channel, 3-31
- deleting the current test plan, 3-32
- deleting the test plan, 6-9
- delta marker, 2-61
- depth mod., disturbances when measuring, 2-31
- DEPTH MOD key, 2-31
- depth of modulation test, 8-28
- DIF GAIN DIF PHAZ key, 2-37
- DIGITAL CH POWER key, 2-42
- DIP switches, 1-11
- display, analog mode, 2-35
- display->card key, 2-12, 2-19, 2-25, 2-28, 2-30, 2-35, 2-41, 2-46, 2-48
- DISPLAY key, 3-28
- display results on screen, system mode, 3-14
- DISP LINE ON key, 2-35
- Dispose User Mem key, 1-6
- disposing of programs, 1-6

DL DELTA ON OFF description, 5-12
DL DELTA ON OFF key, 2-35
DO FRQ RESP TST description, 5-14
DO FRQ RESP TST key, 2-57, 5-14
DONE description, 6-13
DONE key, 3-24, 3-26
DSP LINE ON OFF key, 5-12
DUMP TO PRINTER description, 6-13
DUMP TO PRINTER key, 3-14, 3-2 1
DUMP TO RAM CARD description, 6-16
DUMP TO RAM CARD key, 3-15, 3-21
DUMP TO SCREEN description, 6-17
DUMP TO SCREEN key, 3-14
dynamic range, optimizing, 2-6, 3-6

E edit a test plan, 3-31
ending a measurement, 6-6
ENTER BY CHANNEL description, 6-18
ENTER BY CHANNEL key, 3-23, 3-31
ENTER BY RANGE description, 6-18
ENTER BY RANGE key, 3-25
entering a channel, 6-18
entering a range of channels, 6-18
entering the location, 6-19
entering the start time, 3-20, 6-31
entering the stop time, 3-20, 6-31
entering the temperature, 6-20
entering the time interval for timed testing, 6-34
ENTER LOCATION description, 6-19
ENTER LOCATION key, 3-10, 6-19
ENTER STOP FRQ key, 2-57, 5-23
ENTER STRT FRQ key, 2-57, 5-23
ENTER TEMP description, 6-20
ENTER TEMP key, 3-11
enter the location code, 3-10
enter the temperature, 3-11
error messages, 4-3-11
ALREADY ENTERED, 4-3
CAUTION - Recalled Test Plan **Corrupted**, 4-4
CAUTION - STOP TIME ALREADY PASSED, 4-4
CAUTION - STOP TIME LESS THAN START TIME, 4-5
CHECK CARD IN **SLOT**, 4-5
if a “.” appears in the data fields, 4-13
ILLEGAL **COMMAND**, 4-6
INVALID FILE NO **ROOM**, 4-7
INVALID SYMTAB ENTRY: SYMTAB **OVERFLOW**, 4-6
MUST BE > **FIRST**, 4-7
NO CARD **FOUND**, 4-8

- NO TEST PLAN SELECTED, 4-8
- OUT OF RANGE, 4-9
- PLEASE SELECT A CHANNEL, 4-9
- PRINTER IS NOT CONNECTED, 4-10
- RAM CARD IS NOT FORMATTED, 4-11
- RAM CARD **REQUIRED**, 4-11
- test results not what you expected, 4- 14
- VIDEO SYNC NOT RECOGNIZED, 2-16, 4-11
- excessive analyzer input voltage, 2-5
- EXT AMP GAIN description, 7- 10
- EXT AMP GAIN key, 2-6, 3-6
- EXT AMP NZ FIG description, 7-10
- EXT AMP NZ FIG key, 2-6, 2-19, 3-6
- EXT AMP YES NO description, 7- 11
- EXT AMP YES NO key, 2-6, 2-19, 3-6
- external pad, 2-5, 3-5, 7- 11
- external preamplifier, 2-5, 3-5
- EXT PAD YES NO description, 7- 11
- EXT PAD YES NO key, 2-5, 3-5

F FAST SWEEP key, 2-57, 5-24

- fast time domain sweeps, 2-31
- FCC composite test signal, 2-37
- FCC COMPOSIT key, 2-24, 2-39
- FCC measurement range, carrier to noise, 2-15
- FCC multiburst test signal, 2-51
- Eeld entry, system mode, 3-23, 3-25
- FIELD ODD EVEN key, 2-23, 2-39
- fields, default, 2-7, 3-7
- file length, 6-8
- file name, 6-7
- Ele name for test data, 6-16
- Ele number, 3-21
- files
 - if RAM card Eles are missing, 4- 12
- file title, entering, 3-28
- file title, using external keyboard, 3-28
- file type, 6-7
- finding the beat products
 - CTB testing, 8- 19
- firmware
 - analyzer, xiv
- firmware date, xiv
- flatness, 8-45
- FLD BOTH EVEN ODD key, 2-16, 2-52, 5-17
- FM deviation test, 8-43
- FM DEV key, 2-46
- format a RAM card, 3-37

- FORMAT CARD key, 3-37
- FREQ ON OFF key, 2-12
- FREQ RSLN 10 100 Hz key, 2-12
- frequency allocations, Q-10
- FREQUENCY key, 5-14, 5-23
- frequency response setup, 8-45
- frequency response, using two points, 2-59
- FRQ RSLN 10 100 Hz key, 2-12

G gain, amplifier, 7-10

- gated measurement, channel meas. setup, 2-6
- gated measurement setup, 1-12
- GATE ON OFF description, 5-17
- GATE ON OFF key, 2-16, 2-26, 5-17
- GATING YES NO key, 2-6, 2-16, 2-26, 5-17
- GCR key, 2-52
- GCR test signal, 2-51
- general safety considerations, ix
- getting started, 1-2
- Ghost Cancellation Reference signal, 2-52
- GO TO CSO/CTB key, 2-20
- GOTO PAGE description, 6-21
- GOTO PAGE key, 3-17
- grounding problems, troubleshooting, 2-48
- guide conventions, xiii

H harmonically related carrier tune configuration, selecting, 7-12

hints

- carrier level and frequency test, 2-14
- carrier to noise measurements, 2-20
- CHANNEL SELECT, 5-10
- cross modulation measurement, 2-30
- CSO/CTB measurement, 2-28
- depth of modulation measurement, 2-35
- FAST SWEEP for systems with channels not scrambled, 5-26
- frequency response, 5-15
- hum measurement, 2-49
- recover from wrong keys, 2-11
- reenter CABLE TV ANALYZER mode, 2-11
- return to last used menu, 2-11
- save trace B to internal mem, 5-22
- set power-on default state, 2-11
- SLOW SWEEP to measure vertical sync pulse, 5-26
- step to adjacent channel, 2-11
- system freq response, 5-24

horizontal lines, multiple, 2-33

horizontal-sync suppression scrambling, 8-45

how to contact Hewlett-Packard, 4-16

- HP-IB interface, Option 021, 1-10
- HRC description, 7-12
- HRC key, 2-4, 3-4
- HUM key, 2-48
- hum percentage, 2-48, 8-24
- hum test, 8-24

I if a “.” appears in the data fields, 4-13

- if files are missing from a RAM card, 4-12
- if the test results are not what you expected, 4-14
- ILLEGAL COMMAND error message, 4-6
- immediate testing, 3-14
- impedance matching, 7-11
- IN-CHAN FRQ RSP key, 2-51
- in-channel freq response test, 8-40
- in-channel frq test using VITS, 2-51
- incrementally related carrier tune configuration, selecting, 7-13
- initiating testing, 3-14
- initiating testing later, 6-33
- input configuration, 2-10, 7-7
- input level, maximum, 2-9, 3-8
- input power, measure, 2-9, 3-8
- input voltage, excessive, 2-5
- inserting the card, 1-4
- INTERNAL CARD key, 3-33, 3-39
 - selecting the memory card, 1-6
- internal preamplifier, 2-5
- INTGRTN RNG SET key, 5-18
- INVALID FILE NO ROOM error message, 4-7
- INVALID SYMTAB ENTRY: SYMTAB OVERFLOW error message, 4-6
- IRC description, 7-13
- IRC key, 2-4, 3-4

K key

- guide conventions, xiii

L line numbers, default, 2-7, 3-7

- LINE SEARCH key, 2-16, 5-17
- LISTEN AT MKR key, 2-60
- LISTEN ON OFF description, 5-19
- LISTEN ON OFF key, 2-60
- LOAD FILE key, 1-7
- loading the HP 85721A personality, 1-4
- location code
 - entering, 3-10
 - range, 6-19

M Main Menu description, 6-21
 MAIN MENU key, 2-60
 map, channel survey, 9-23
 MARKER DELTA key, 5- 15
 MARKER OFF key, 2-58, 5-15
 MARKER ON key, 2-58, 5-15
 MARKER A key, 2-58
 matching impedance, 7- 11
 matching pad, 50 ohm analyzers, 2-5
 MAX HOLD ON OFF key, 2-12
 maximum input level, 2-9, 3-8
 measurements
 carrier level and frequency, 2-12
 carrier to noise, 2- 15
 channel mode, 2-2
 chroma/luma delay inequality, 2-22
 cross modulation, 2-30
 CSO/CTB, 2-26
 differential gain/phase, 2-37
 Digital Channel Power Measurement, 2-42
 FM deviation, 2-46
 hum, 2-48
 in-channel freq response, 2-51
 modulation and noise reduction, 2-60
 system CSO/CTB, system mode, 3- 14
 system frequency response, 2-57
 system measurement mode, 3-2
 “white noise” of channel relative to peak sync pulse level, 2-31
 measurement steps, system mode, 3-3
 measurement trace, 5-14
 Measure Now description, 6-22
 Measure Now key, 3- 14
 memory card
 inserting, 1-4
 store results, 2-12, 2-19, 2-25, 2-28, 2-30, 2-35, 2-41, 2-46, 2-48
 store results, system mode, 3-17, 3-21
 menu map, 6-3
 menu maps
 AUX CTRL, 7-5
 channel measurement, 5-3
 DISPLAY, 5-6
 setup, 7-4
 TV receiver, 7-3
 menus maps
 system measurement mode, 6-4
 messages
 CHANNEL TURNED ON?, 2-28
 (ENTER 0-5 or 11 ‘THRU MAX REG #’), 5-21
 FCC MEASUREMENT RANGE, 2-15

PLEASE SELECT A CHANNEL, 2-15, 2-26
REGISTER #, 5-20
(See MORE INFO), 2-15
SETUP FINISHED SAVE THIS REFERENCE TRACE, 5-24
TRACE B SAVED, 5-25
minimum hold function, 2-61
missing files, 4-12
MODE key, 1-14, 5-23
modulated staircase, diff gain/phase, 2-38
Monitor TV description, 7-13
MORE INFO key, 2-19, 2-34, 2-41, 2-48, 2-52
More key, 2-27
MULTI-BURST key, 2-52
MUST BE > FIRST error message, 4-7

N NEXT BEAT key, 2-27
NEXT CHANNEL key, 2-12
NEXT PAGE description, 6-22
NEXT PAGE key, 3-17
NO CARD FOUND error message, 4-8
NO description, 6-23
noise figure, amplifier, 7-10
noise level, 2-15
non-interfering
 carrier to noise, 2-16
 CSO/CTB measurement, 2-26
 measurement setup, 1-12
 select from Setup menu, 2-6
 select pause before measuring, 2-7
notes
 frequency response without recalling reference, 5-16
 STOP TEST to exit frequency response, 5-16
NO TEST PLAN SELECTED error message, 4-8
NTC 7 CMBNTN key, 2-52
NTC 7 composite test signal, 2-38
NTC 7 COMPOSIT key, 2-39
NTC 7 test signal, 2-51
NTSC, 8-35
number of records, 6-7

- O # OF AVERAGES key, 2-40
 - offset
 - CTB testing, 8- 19
 - offset, CLDI, 2-24
 - off-the-air tune configuration, selecting, 7-6
 - option 101, Fast Time-Domain Sweeps, 2-32
 - option 102, 2-46
 - option 102, TV Sync, 2-32
 - option 301, 2-46
 - options, analyzer, 1-3
 - other problems, 4-12-15
 - OUT OF RANGE error message, 4-9

- P packet (5th), exclude from measurement, 2-39
 - PAL, 8-35
 - pause before gated meas., 2-7
 - pause before video meas., channel mode, 2-7
 - PAUSE YES NO key, 2-7, 5-17
 - peak sync pulse level, 2-31
 - personality, description of, x
 - picture and sound, 7- 14
 - PICTURE ON OFF description, 7-14
 - PIX &SND ON OFF description, 7- 14
 - PIX &SND ON OFF key, 2-63
 - PLAN 1 description, 6-23
 - PLAN 2 description, 6-24
 - PLAN 3 description, 6-25
 - PLAN 4 description, 6-25
 - PLAN 5 description, 6-25
 - PLEASE SELECT A CHANNEL error message, 4-9
 - power line components, 2-48
 - power, measure input, 2-9, 3-8
 - preamplifier
 - default gain, 2-6
 - default noise figure, 2-6
 - enter gain, 2-6
 - enter noise figure, 2-6
 - external, 2-6, 2-19, 3-6
 - internal (HP 8591C), 2-19, 3-6
 - needed for carrier to noise, 2- 15
 - Prev Menu description, 6-26
 - PREV PAGE description, 6-26
 - Print Config, 1-1 1
 - PRINT CONFIG key, 1- 11
 - printer
 - connecting a printer, 1-10
 - copy results, 2-25, 2-28, 2-30, 2-35, 2-41. 2-46, 2-48
 - dump to from system mode, 3-14

- dump to printer, system mode, 3-21
- HP-IB interface, 1-10
- print results, 2-12, 2-19
- print results, system mode, 3-17
- RS-232 interface, 1-11
 - setting the baud rate, 1-11
 - setting the HP-IB address, 1-11
- PRINTER ADDRESS key, 1-11
- PRINTER IS NOT CONNECTED error message, 4-10
- printing the test data stored on a RAM card, 6-10
- PRINT REPORT description, 6-26
- PRINT REPORT key, 3-17

Q quiet line entry, system mode, 3-23, 3-25
quiet line search, auto, 2-16

R RAM card

- if files are missing, 4-12
- printing the test data, 6-10
- RAM CARD IS NOT FORMATTED error message, 4-11
- RAM CARD **REQUIRED** error message, 4-11
- real-time clock
 - setting the time and date, 4-15
- recall a test plan from analyzer memory, 3-12
- recall a test plan from RAM card, 3-34
- Recall Data description, 6-27
- Recall Data key, 3-35
- RECALL FRM CRD description, 6-27
- RECALL FRM CRD key, 3-34
- RECALL FRM INT, 6-28
- RECALL FRM INT description, 5-20, 6-28
- RECALL FRM INT key, 2-57, 3-12, 5-14
- recalling
 - what is recalled with the test plan, 6-24
- recalling a test plan from analyzer memory, 6-28
- recalling test data from a RAM card, 6-27
- RECALL key, 3-33, 3-39
- recall test data from RAM card, 3-35
- Recall TstPlan description, 6-29
- receiver mode, select, 7-20
- reference, 5-23
- reference measurement, 5-23
- reference noise level, 2-15
- reference point, 5-14
- reference spectrum, 8-45
- reference trace, 5-14, 5-21, 8-45
- register number, 5-14, 5-25
- requirements, analyzer, 1-2

- resolution bandwidth, 2-60
- RESTART AVERAGING key, 2-27
- results, print, 2-12
- results to screen, 6-17
- ripple, 5-14
- RS-232 interface, Option 043, 1-11
- run a test later, 3-20
- run a test now, 3-14

S safety, ix

- safety symbols, viii
- sales and service office, 4-16
- sales and service office table, 4-17
- SAVE key, 3-33, 3-39, 5-22
- SAVE TO INT MEM description, 6-29
- SAVE TO INT MEM key, 3-28
- SAVE TO MEM CARD key, 3-30
- SAVE TRB TO INT description, 5-21
- SAVE TRB TO INT key, 2-57, 5-20, 5-25
- Save TstPlan description, 6-30
- Save TstPlan key, 3-28
- saving a test plan, 3-28
- saving a test plan in analyzer memory, 6-29
- SCRAMBLD YES NO key, 2-12
- scrambled channel, system mode, 3-23
- scrambled status, over a range, 3-25
- scrambling, 8-45
- screen, send results to, 6-17
- screen text font
 - guide conventions, xiii
- select a channel individually, 3-23
- select all tests, 6-6
- select a range of channels, 3-25
- select channel, 7-8
- selected channels, view, 3-24, 3-26
- selecting all the tests, 3-23, 3-25
- selecting the tune configuration, 7-8
- SELECT LINE key, 2-16, 2-23, 2-39
- select next page, 3-17
- Select Test Sig key, 2-39, 2-52
- Select Test Sig key, CLDI, 2-24
- self-calibration routines, 1-8
- Set B&W Printer key, 1-11
- setting the start time, 6-31
- setting the stop time, 6-31
- setting the time and date, 4-15
- setting the time interval for timed testing, 6-34
- Setup description, 7-15

- setup gated meas, channel mode, 2-6
- Setup key, 2-4, 3-4
- signal connections to analyzer, 2-9, 3-8
- SIN X/X key, 2-52
- sin x/x test signal, 2-51
- SLOW SWEEP key, 2-57, 5-24
- smoothing trace, 2-18
- softkey
 - guide conventions, xiii
- softkeys
 - system menu map, 6-3
- software product license agreement, iii-7
- SOUND ON OFF description, 7-16
- span, user defined channel, 7-21
- specifications, 9-2, 9-3
 - carrier to noise ratio, 9-5
 - channel selection, 9-3
 - color tests, Q-Q
 - cross modulation, Q-7
 - CSO/CTB distortion, 9-6
 - depth of modulation, 9-5
 - Digital Channel Power, 9-5
 - FM deviation, 9-5
 - frequency response setup, 9-8
 - frequency response test, 9-8
 - hum, 9-5
 - input configuration, 9-3
 - non-interfering, gate on, Q-Q
 - Option 704 freq reference, 9-4
 - precision freq reference, 9-4
 - visual carrier freq, 9-3
 - visual carrier level, 9-4
 - visual to aural carrier freq difference, 9-4
 - visual to aural carrier level difference, 9-4
- SPECTRUM ANALYZER key, 3-18
- spectrum analyzer mode
 - how to access, 2-62, 3-18
- staircase packet (5th), exclude from measurement, 2-39
- standard tune configuration, selecting, 7-16
- starting address, 6-7
- START TIME description, 6-31
- START TIME key, 3-20
- STD description, 7-16
- STD key, 2-4, 3-4
- stopping a measurement, 6-6
- STOP TEST key, 2-58
- STOP TIME, 3-20
- STOP TIME description, 6-31
- store data to RAM card, 6-30

- STORE TO CARD description, 6-30
- STORE TO CARD key, 3-17
- storing calibration results, 1-8
- storing test results, 6-16
- supported analyzers, 1-2
- support information, 9-2
- survey map, 9-23
- survey system, 3-22
- swept in-channel freq response, 2-51
- SWP TEST SETUP key, 2-51
- SYS BTS TST CHNL description, 7-17
- SYS BTS TST CHNL key, 3-7, 3-14
- System Beats description, 7-18
- System Beats key, 3-7
- system beats, measurement setup, 3-7
- system carrier to noise, 2-15
- system flatness, 8-45
- system frequency response, 8-45
- SYSTEM FRQ RESP key, 2-57
- SYSTEM MEAS description, 6-32
- system menu map, 6-3
- system mode, 3-2

T TAKE REF TRACE description, 5-23

- TAKE REF TRACE key, 2-57, 5-14
- T description, 7-19
- Television Broadcast Station Identification, 9-10
- Television station assigned frequencies, 9-10
- temperature
 - entering, 3-11
- test and functions
 - Digital Channel Power Measurement, 2-42
- test channel
 - CTB testing, 8-19
- test descriptions, 8-2
 - carrier-to-noise ratio, 8-7
 - chroma/luma delay inequality, 8-33
 - cross modulation, 8-44
 - cso, 8-16
 - CTB, 8-18
 - depth of modulation, 8-28
 - differential gain, 8-33
 - differential phase, 8-33
 - FM deviation, 8-43
 - hum, 8-24
 - in-channel freq response, 8-40
 - system freq response, 8-45
 - view co-channel, 8-47

- view ingress, 8-46
- visual carrier frequency, 8-5
- visual carrier level, 8-3
- visual-to-aural carrier frequency difference, 8-5
- visual-to-aural level difference, 8-3
- testing, system mode, 3-14
- test list, system mode, 3-2
- test plan
 - creating, 3-22
 - definition, 3-22
 - recalling test plan from analyzer memory, 3-12
 - what is recalled with the test plan, 6-24
- test plan contents, 6-23
- Test Plan description, 6-10
- test plan, recall, 6-29
- test plan, recall from card, 6-27
- test plan, stored parameters, 3-29
- test results
 - not what you expected, 4-14
- test results, view last, 6-36
- tests and functions
 - abort measurement, 6-6
 - analyzer input setup, 7-7
 - carrier level, 2-12
 - carrier to noise, 2-15
 - channel select, 5-9
 - channel tuning, 7-8
 - chroma/luma delay, 2-22
 - clear all tests, 6-9
 - clear current test plan, 6-9
 - co-channel interference, 5-27
 - composite second order, 2-26
 - composite triple beat, 2-26
 - create test plan, 6-10
 - cross modulation, 2-30
 - data to printer, 6-10
 - default setup configuration, 7-15
 - depth of modulation, 2-31
 - differential gain/phase, 2-37
 - display line delta, 5-12
 - done, 6-13
 - enter channel number, 6-18
 - enter location, 6-19
 - enter range of channels, 6-18
 - enter temperature, 6-20
 - external/internal amplifier gain, 7-10
 - external/internal amp noise figure, 7-10
 - FM deviation, 2-46
 - frequency offset, CSO/CTB, 7-9

frequency response, 5-14
frequency response setup, 5-23
gated measurements, 5-17
HRC tune configuration, 7-12
hum measurement, 2-48
inchannel frequency response, 2-51
initiate immediate measurement, 6-22
IRC tune configuration, 7-13
listen on off, 5-19
list files on RAM card, 6-7
main menu, 6-21
no, 6-23
off the air, 7-6
picture and sound, 7-14
picture on off, 7-14
print report, 6-26
recall data from RAM card, 6-27
recall test plan, 6-28, 6-29
recall test plan from RAM card, 6-27
recall trace B from internal, 5-20
results to printer, 6-13
results to RAM card, 6-16
save data to RAM card, 6-30
save test plan, 6-29, 6-30
save to plan number, 6-23, 6-24, 6-25
save trace B to internal memory, 5-21
select all tests, 6-6
select channel, 7-8
select external/internal amp, 7-1 1
select external pad, 7-1 1
select next page of results, 6-22
select page of results, 6-21
select previous menu, 6-26
select previous page, 6-26
select time interval, 6-34
set date, today, 6-35
set time and date, 6-35
sound on off, 7- 16
start time, timed measurements, 6-31
stop time, timed measurements, 6-31
system beats testing, 7- 17, 7- 18
system frequency response, 2-57
system measurement mode, 6-32
timed measurements, 6-33
total input power, 7-20
T tune configuration, 7-19
TV receiver mode, access, 7- 13
TV receiver, select, 7-20
user defined channel, 7-21

- user defined span, 7-2 1
- view channel selection, 6-36
- view ingress, 2-60
- view last test results, 6-36
- yes, 6-37
- tests, channel, 2-2
- tests, clear all, 6-9
- test signal line entry, system mode, 3-23, 3-26
- test signal search, auto diff gain/phase, 2-37
- test signals, in-channel freq response, 2-53
- test signals, in-channel frq test, 2-51
- test signal timing, 2-23
- TEST SIGNAL type entry, system mode, 3-23, 3-26
- THINKJET SWITCHES key, 1-11
- time
 - setting the time, 4-15
- time and date entry
 - RAM files, 6-16
- Timed Measure description, 6-33
- Timed Measure key, 3-20
- timed testing, 3-20
- time interval, 3-20
 - maximum time interval, 6-34
- TIME INTERVAL description, 6-34
- TIME INTERVAL key, 3-20
- time of creation, 6-8
- time-varying scrambling, 8-45
- timing, non-standard test signal, 2-23
- title entry, file, 3-28
- title entry, using external keyboard, 3-28
- T key, 2-4, 3-4
- TODAY'S DATE description, 6-35
- TODAY'S DATE key, 3-20
- TODAY'S TIMEDATE description, 6-35
- TODAY'S TIMEDATE key, 3-20
- total hum percentage, 2-48, 8-24
- total input power, measure, 2-6, 3-6
- total power, input, 7-20
- TOTL PWR @ INPUT description, 7-20
- TOTL PWR @ INPUT key, 2-6, 2-9, 3-6, 3-8
- TRACE key, 2-33
- trace number, 5-20
- trace register, 5-21
- trace register number, 5-25
- trace registers, 3-33
- T tune configuration, 7- 19
- tune configuration, 2-4, 3-4
- tune configuration, AIR, 7-6
- tune configuration, HRC, 7-12

- tune configuration, IRC, 7-13
- tune configuration. selecting, 7-8
- tune configuration, STD, 7-16
- TV frequencies, 9- 10
- TV IN connector, 2-9
- TV line, 2-31
- TV LINE # key, 2-32
- TV RECEIVER description, 7-20
- TV RECEIVER key, 2-63, 3-19
- TV receiver mode
 - how to access, 2-63, 3-19
- TV sync, 2-31
- TV TRIG EVEN FLD key, 2-34
- TV TRIG ODD FLD key, 2-34
- TV TRIG VERT INT key, 2-34

U updating firmware, xiv

- user defined center freq, 7-21
- user defined channel, 2-4
- user defined span, 7-21
- USR CH 0 CNTR FRQ description, 7-21
- USR CH 0 CNTR FRQ key, 2-4
- LJSR CH 0 SPAN description, 7-21
- USR CH 0 SPAN key, 2-4

V valid channel numbers, 3-23

- VID AVG ON OFF key, 2-33
- video average, depth mod., 2-33
- VIDEO SYNC NOT **RECOGNIZED** error message, 4-11
- view channel selection, 6-36
- VIEW CH SEL description, 6-36
- VIEW CH SEL key, 3-24, 3-26
- view co-channel test, 8-47
- VIEW CO-CHNL description, 5-27
- VIEW CO-CHNL key, 2-60
- VIEW INGRESS key, 2-60, 527
- view ingress test, 8-46
- VIEW LAST description, 6-36
- view last test results, 6-36
- visual carrier, 5- 10
- visual carrier frequency test, 8-5
- visual carrier level test, 8-3
- VITS, 3-3
- VITS TEST key, 2-51
- voltage, excessive input, 2-5
- volume. 5- 19

W warmup time, 1-8
warning
 the warning symbol, viii
warranty, vi
waveform analyzer, depth mod., 2-33
white noise, 2-31
WINDOWS, 3- 19
WINDOWS keys, 2-63
wrong date or time is displayed, 4-15

Y YES description, 6-37